

Operating Instructions

LCD PROJECTOR

Model No. **PT-L758U**

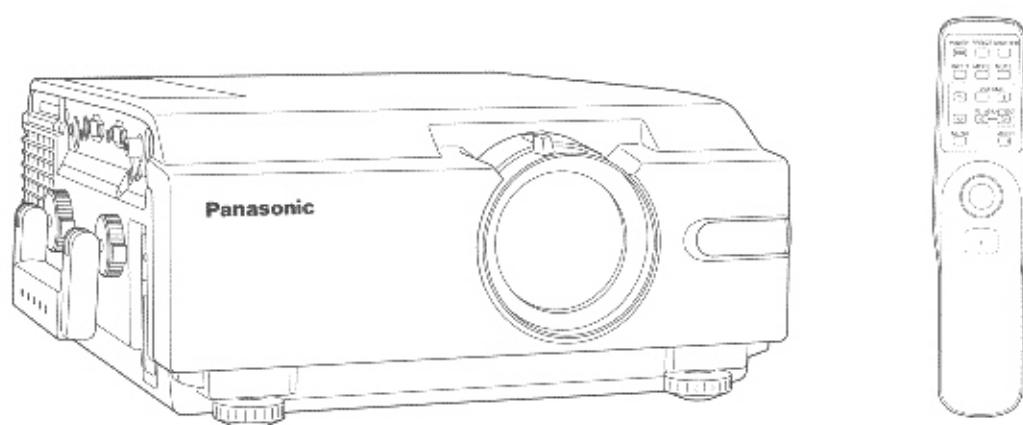

Panasonic®

Please read these instructions completely before operating this LCD Projector.

Things You Should Know

Caution: This equipment has been tested and found to comply with the limits for a Class B digital device, pursuant to Part 15 of the FCC Rules. These limits are designed to provide reasonable protection against harmful interference in a residential installation. This equipment generates, uses, and can radiate radio frequency energy and, if not installed and used in accordance with the instructions, may cause harmful interference to radio communications. However, there is no guarantee that interference will not occur in a particular installation. If this equipment does cause harmful interference to radio or television reception, which can be determined by turning the equipment off and on, the user is encouraged to try to correct the interference by one or more of the following measures:

- Reorient or relocate the receiving antenna.
- Increase the separation between the equipment and receiver.
- Connect the equipment into an outlet on a circuit different from that to which the receiver is connected.
- Consult the dealer or an experienced radio/TV technician for help.

FCC Warning: To assure continued FCC compliance, use only the provided grounded power supply cord and prevent undesirable interference, use only the provided shielded VGA cable with 2 ferrite cores while connecting LCD to computer and all other connecting cables should be shielded. Any changes or modifications not expressly approved by the party responsible for compliance could void the user's authority to operate this equipment.

Declaration of Conformity

Model Number: PT-L758U
Trade Name: **Panasonic**
Responsible party: Matsushita Electric Corporation of America.
Address: One Panasonic Way Secaucus New Jersey 07094
Telephone number: 1-800-528-8601

This device complies with Part 15 of the FCC Rules, Operation is subject to the following two conditions:
(1) This device may not cause harmful interference, and (2) this device must accept any interference received, including interference that may cause undesired operation.

Congratulations

On your purchase of one of the most sophisticated and reliable products on the market today. Used properly, we're sure it will bring you and your family years of service enjoyment. Please take time to fill in the information below. The serial number is on the tag located on the back of your LCD Projector. You'll want to keep this manual handy as your convenient LCD Projector information source. For your own protection and prolonged operation of your LCD Projector, please be sure to read the "Important Safeguards" carefully, before use.

Date of Purchase _____

Dealer Purchased From _____

Dealer Address _____

Dealer Phone No. _____

Model No. **PT-L758U** _____

Serial No. _____

Table of Contents

Things You Should Know	2	Adjusting the Image Position,	
Important Safeguards	3	Horizontal Size and Phase	26
LCD Projector Features	5	Using Other Useful Functions	27
Contents of LCD Projector Box	6	System Configuration Example	30
Product Information	6	Projecting the DTV Format Signal	34
Turning the power on and off	9	Projecting PC-Card (ATA Flash Card) Data	35
Screen Requirements	10	Saving the Image Data to a PC-Card	
Standard Setting-up Positions	11	(applies to LCD Projector only)	37
Adjusting the Lens	13	JPEG Viewer Feature	40
Displaying the on-screen menu screens	13	Status Code Display Indications	45
Setting-up Positions and Changing the		Removing and Attaching the Carrying Handle	46
Projection Mode	14	Cleaning the Air Filter	47
Setting the Screen Type	15	Lamp Replacement	48
Basic LCD Projector Operation	16	Before Requesting Service	50
Selecting the Picture Mode	22	Specifications	51
Adjusting the Picture to the Desired Setting	23	Notes importantes concernant la sécurité	52
Adjusting the White Balance	24	Remplacement de la lampe	54
Selecting the Image Quality	25	Wichtige Sicherheitshinweise	56
Using the Auto Setup Feature	25	Lampenaustausch	58

© 1999 Matsushita Electric Industrial Co., Ltd

All product/brand names are trademarks or registered trademarks of the respective holders.

Important Safeguards



CAUTION: Please read all of these instructions before you operate your LCD Projector. Save these instructions for future reference.

Electrical energy can perform many useful functions. This LCD Projector has been engineered and manufactured to meet applicable safety standards. But **IMPROPER USE CAN RESULT IN POTENTIAL ELECTRICAL SHOCK OR FIRE HAZARDS**. In order not to defeat the safeguards incorporated into this LCD Projector, observe the following basic rules for its installation, use and servicing.

- 1 Unplug the LCD Projector from the wall outlet before cleaning.
- 2 Do not use liquid cleaners or aerosol cleaners. Use a soft dry cloth to clean the LCD Projector unit. If the unit is very dirty, wet a cloth with neutral detergent, squeeze it tight, wipe the unit with it, and finish by wiping with a dry cloth. Do not use a chemical duster or polisher-cleaner because it can adversely affect the unit and peel the paint coat.
- 3 Do not use attachments not recommended by Panasonic, as they may cause hazards.
- 4 Do not use the LCD Projector near water; for example, near a bathtub, washbowl, kitchen sink, laundry tub, in a wet basement, near a swimming pool, etc. Never spill liquid into the LCD Projector.
- 5 Do not place the LCD Projector on an unstable cart, stand, or table. The LCD Projector may fall, which may cause serious injury to a child or an adult, and/or serious damage to the unit. Use only with a cart or stand recommended by its manufacturer, as being suitable for use with the LCD Projector.
- 6 Ceiling, wall or shelf mounting for installation should use a mounting kit approved by the manufacturer for use with the LCD Projector and should follow the manufacturer's instructions.
- 7 The LCD Projector equipment and cart combinations should be moved with care. Quick stops, excessive force, and uneven surfaces may cause the equipment and cart combination to overturn.
- 8 Slots and openings in the cabinet back and bottom are provided for ventilation. To ensure reliable operation of the LCD Projector and to protect it from overheating, these openings must not be blocked or covered. These openings should never be covered with cloth or other material. The bottom opening should not be blocked by placing the LCD Projector on a bed, sofa, rug, or other similar surface. The LCD Projector should not be placed near or over a radiator or heating vent. The LCD Projector should not be placed in a built-in installation such as a bookcase unless proper ventilation is provided.
- 9 The LCD Projector should be operated only from the type of power source indicated on the back of the LCD Projector or in the specifications. If you are not sure of the type of power supplied to your home, consult your LCD Projector dealer or local power company.
- 10 Do not allow anything to rest on the power cord. Do not place the LCD Projector where the cord will be walked on.
- 11 Follow all warnings and instructions marked on the LCD Projector.
- 12 As a safety feature, the LCD Projector is equipped with a 3-prong grounded plug. The 3-prong grounded plug will fit only into a grounding type power outlet. If the plug does not fit, use an adaptor that is properly grounded or have an electrician install a grounded type outlet. Do not attempt to modify this AC plug.
- 13 For added protection of the LCD Projector during a lightning storm, or when it is left unattended or not in use for long periods of time, unplug it from the wall outlet and disconnect any cable systems. This will prevent damage to the projector due to lightning and power-line surges.
- 14 Do not overload wall outlets and extension cords with too many products, because this can result in fire or electric shock.



- 15** Never push objects of any kind into the LCD Projector through cabinet slots as they may touch dangerous voltage points or short out parts, which could result in a fire or electric shock.
- 16** Do not attempt to service the LCD Projector yourself. Opening or removing covers may expose you to dangerous voltage or other hazards. Refer all servicing to qualified service personnel.
- 17** Unplug the LCD Projector equipment from the wall outlet and refer servicing to qualified service personnel under the following conditions:
 - A. When the power cord or plug is damaged or frayed.
 - B. If liquid has been spilled into the LCD Projector.
 - C. If the LCD Projector has been exposed to rain or water.
 - D. If the LCD Projector does not operate normally when you follow the operating instructions. Adjust only those controls that are covered by the operating instructions; improper adjustment of other controls may cause damage and will often require extensive work by a qualified technician to restore the LCD Projector to normal operation.
 - E. If the LCD Projector has been dropped or the cabinet has been damaged.
 - F. When the LCD Projector exhibits a distinct change in performance – this indicates a need for service.
- 18** Upon completion of any service or repairs to the LCD Projector, ask the service technician to perform a routine safety check to determine that the LCD Projector is in safe operating condition.
- 19** When replacement parts are required, be sure the service technician has used replacement parts specified by the manufacturer that have the same characteristics as the original parts. Unauthorized substitutions may result in fire, electric shock, or other hazards.
- 20** Air filter should be cleaned every 100 lamp on hours.
The LCD Projector may become too hot if filter is not cleaned when required.
- 21** If lens becomes dirty, or smudged, clean with a clean, dampened cloth. Never touch the lens with your fingers.
- 22** Do not look directly into the aperture and lens while operating as this may result in damage to your eyes.
- 23** Do not look into the red Laser Pointer transmitter, or aim the Laser beam at a person. Shining the Laser beam into the eyes could result in eye damage.

LCD Projector Features

1 High Brightness and Resolution

786,432 (1024 X 768) pixels X 3 panels format, 2,500-lumen (ANSI) offers clear images even when ambient light level is high.

2 Compact and Lightweight

Completely portable, you can give attractive presentations at any location by connecting the PT-L758U to a computer or video equipment.

3 20 to 300 Inch Screen Capability

Project a screen size of 20" to 300" from a distance of 2.62 feet to 44.29 feet. (See page 11.)

4 Compatible with Most Personal Computers

The RGB input accepts signals from VGA, SVGA, XGA, SXGA (Compression), and MAC compatible computers with no additional hardware. Other compatible computers require a separate cable.

5 Accommodates 6 different video signal standards

The LCD Projector accepts the input signal of all major video formats, including PAL, SECAM, NTSC, PAL-M, PAL-N, NTSC4.43, and the higher quality S-Video signals. And, input of DTV Format Signal, such as the Component (YPbPr) signal from a DVD is also possible with this Projector. And, the Projector can also display even higher quality Component signals generated by HDTV equipment.

6 On Screen Display

The LCD Projector's language is set to English at the factory. In addition, you can select Spanish, French, German, Italian, Japanese and Chinese. Information screens and menus make setting up and operating the LCD Projector extremely easy.

7 IR Remote Control

Front and rear sensors allow you to control the LCD Projector from almost anywhere in the room.

8 Laser Pointer on the Remote Control

When the Laser beam is aimed at the screen, the Pointer is displayed on the screen.

9 Wireless mouse

This function lets you use the remote control to control a personal computer in place of the personal computer's mouse. (See page 33.)

10 Stereo Audio Output

For external audio equipment connection. Audio follows video source.

11 Capture Feature

The LCD Projector can record and store the projected image in memory or to a PC-Card. And you can project the image stored in memory as a back-screen while the LCD Projector is starting-up and also when you press SHUTTER. (See pages 29, 37.)

12 Projecting PC-Card (ATA Flash Card) Data

Using this software, "JPEG Viewer", you can save the image displayed on the PC screen as a JPEG file, to a PC-Card (ATA Flash Card). And if you insert the PC-Card into the LCD Projector, you can project using the JPEG Image playback feature. (See page 35.)

13 Automatic Universal Power Supply with Automatic Power Down

This unit has an operating voltage range of AC 100 - 240V. The lamp power is automatically turned off if there is no Input Signal for 15 minutes.

Equipped with a variety of convenient functions

A variety of functions such as the following have been provided.

- A blue screen is projected when no signal is being input.
- Mute or freeze functions for video and audio signals can be toggled on and off.
- The input signal display function can be toggled on and off.
- Cancellation of the enlarging function is provided.
- 16:9 (wide) screen projection is provided.
- The function of the POWER Button on the remote control can be disabled.
- Four direction types are provided.

Contents of LCD Projector Box

Please confirm that the following items are packed in the LCD Projector box. They are provided to help you use or set up your LCD Projector.

- (1) LCD Projector
- (2) Remote Control unit (LRQ90042)
- (3) 2 "AA" Batteries
- (4) Lens Cap
- (5) Carrying Handle
- (6) 9.8 Foot UL/CSA Power Cord (VJAS0179)
- (7) VGA Cable (LSJA0239)
- (8) PS/2 Mouse Cable (LSJA0212)
- (9) MAC Mouse Cable (LSJA0214)
- (10) VGA MAC Adaptor (LSJA0158)
- (11) Audio Cable (LSJA0240)
- (12) Video Cable (LSJA0074)
- (13) 3.5 inch Floppy Disk of JPEG Viewer for Windows 95/Windows 98 (LSFT0191)
- (14) Operating Instructions (Please read completely before operating.)
- (15) Warranty Card
- (16) Service Center List

Product Information

Remote Control unit

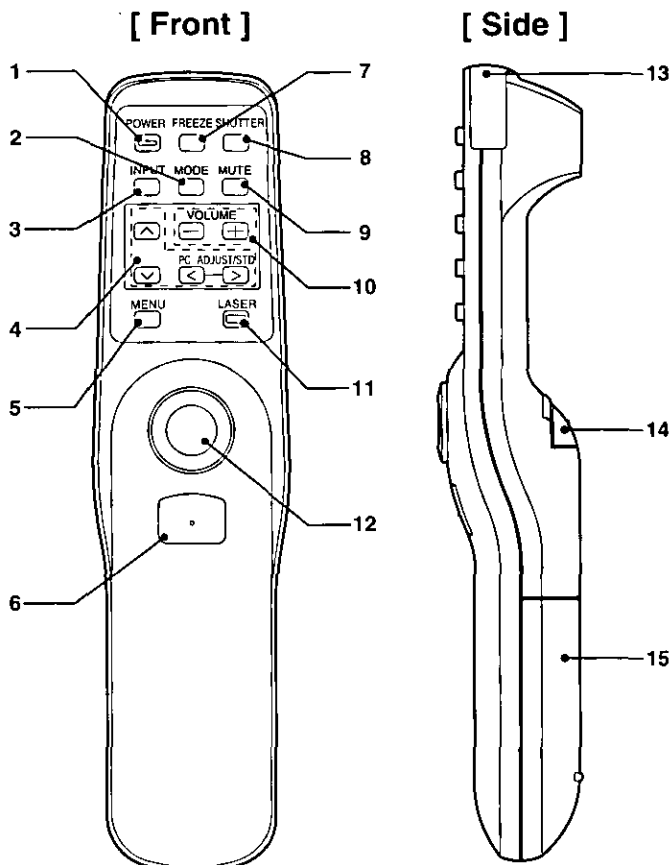

- 1 POWER Button**
See page 9.
- 2 MODE Button**
See page 22.
- 3 INPUT Button**
See page 16.
- 4 Adjust $\wedge/\vee/\langle/\rangle$ Buttons**
See pages 14, 19, 23.
- 5 MENU Button**
See page 13.
- 6 Click 2 Button**
See page 33.
- 7 FREEZE Button**
See page 21.
- 8 SHUTTER Button**
See page 20.
- 9 MUTE Button**
See page 20.
- 10 VOLUME +/- Buttons**
See pages 20, 31, 32, 34, 35.
- 11 LASER Button**
See page 7.
- 12 Mouse Button**
See page 33.
- 13 Transmitter**
- 14 Click 1 button**
See page 33.
- 15 Battery compartment**

LCD Projector

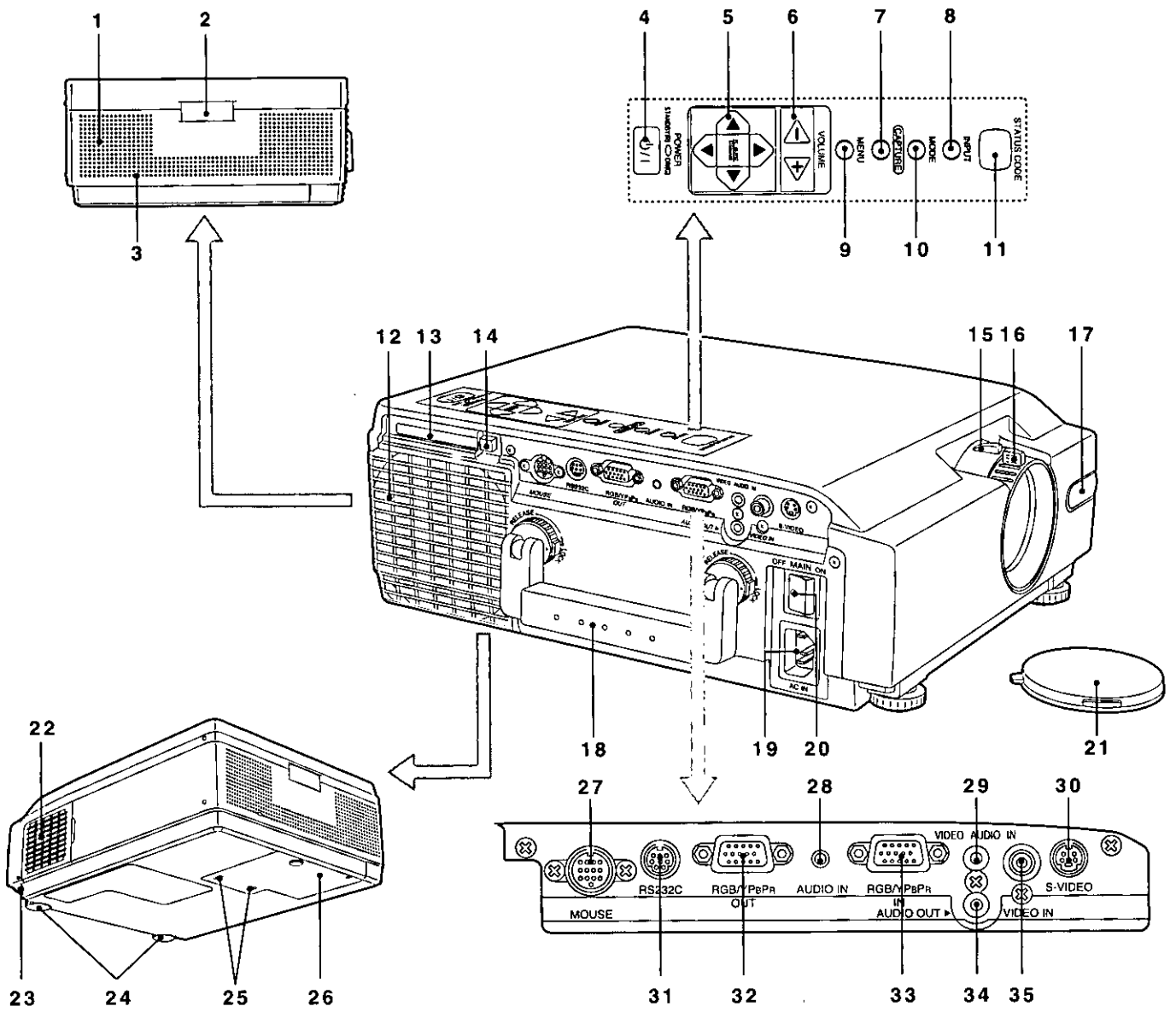

- | | | |
|----|---|-----------------------------------|
| 1 | Speaker | |
| 2 | Remote Control Sensor | |
| 3 | Security Lock | |
| 4 | POWER Button/STANDBY(R) ON(G) Indicator | See page 9. |
| 5 | Adjust $\wedge/\vee/\lt;/>$ Buttons | See pages 14, 21, 25, 49, 55, 59. |
| 6 | VOLUME+/- Buttons | See pages 20, 35, 36, 38, 39. |
| 7 | CAPTURE Button | See page 29. |
| 8 | INPUT Button | See page 16. |
| 9 | MENU Button | See page 13. |
| 10 | MODE Button | See page 22. |
| 11 | STATUS CODE | See page 45. |
| 12 | Air outlet port | |
| 13 | PC-CARD Slot | See page 35. |
| 14 | PC-CARD RELEASE Button | See page 35. |
| 15 | Zoom Ring | See page 13. |
| 16 | FOCUS Ring | See page 13. |
| 17 | Remote Control Sensor | |
| 18 | Carrying Handle | See page 46. |
| 19 | AC Socket (100 - 240 V) | See page 9. |
| 20 | Main Power Switch | See page 9. |
| 21 | Lens Cap | |
| 22 | Air Filter | See page 47. |
| 23 | Adjuster Button | |
| 24 | Adjustable legs | See page 12. |
| 25 | Lamp Cover Screw | See pages 49, 55, 59. |
| 26 | Lamp Cover | See pages 49, 55, 59. |
| 27 | MOUSE Connector | See page 30. |
| 28 | RGB Audio Input Connector | See page 30,32. |
| 29 | Video Audio Input Connector | See page 31. |
| 30 | S-Video Input Connector | See page 31. |
| 31 | RS232C Connector | |
| 32 | RGB/YPBPR Output Connector | See page 30. |
| 33 | RGB/ YPBPR Input Connector | See page 30,32. |
| 34 | Audio Output Connector | See pages 30- 31. |
| 35 | Video Input Connector | See page 31. |

MicroSaver and Kensington are registered trademarks of Kensington Technology Group. All product names mentioned in this document are trademarks or registered trademarks of their respective owners. © 1998 Kensington Technology Group.

Kensington Technology Group
 2885 Campus Drive
 San Mateo, CA 94403, U.S.A

Phone : (650)572-2700
 Fax : (650)572-9675



Turning the power on and off

If the MAIN Power switch on the LCD Projector is pressed while the cooling fan is still operating, the operating life of the projector lamp will be shortened. Be sure to follow the procedures given below when turning the LCD Projector power supply on and off.

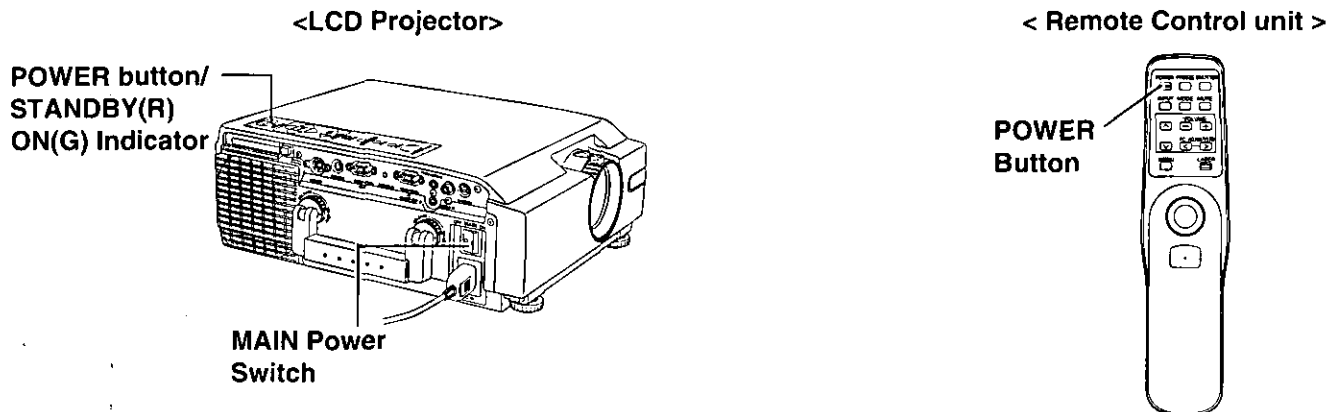

Note: Insert Power Cord into LCD Projector AC socket and connect to properly grounded wall outlet.



Turning on the power

<p>1. Press the MAIN POWER switch (LCD Projector)</p> 	<p>Press the MAIN POWER switch on the LCD Projector to ON.</p> <p style="text-align: center;">↓</p> <p>The power indicator will illuminate red and the Projector will switch to standby mode.</p>
<p>2. Press the POWER button (LCD Projector) (Remote control)</p>  	<p>Press POWER button on the LCD Projector or remote control.</p> <p>The power indicator will alternate from orange to flashing green. ↓</p> <p>The power indicator will illuminate solid green and a picture will be projected onto the screen after about 45 seconds.</p>

Turning off the power

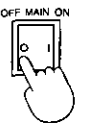
<p>1. Press the POWER button (LCD Projector) (Remote control)</p>  	<p>Press POWER button on the LCD Projector or remote control.</p> <p style="text-align: center;">↓</p> <p>The power indicator will illuminate flashing orange and the Projector will switch to standby mode.</p>
<p>2. Wait for the cooling fan to stop.</p>	<p>Wait for a while (approximately 60 seconds) until the cooling fan stops. (When the fan stops, the power indicator will illuminate solid red.)</p>
<p>3. Press the MAIN POWER switch (LCD Projector)</p> 	<p>Press the MAIN POWER switch on the LCD Projector to OFF.</p> <p style="text-align: center;">↓</p> <p>The power indicator will switch off and the power supply will be turned off.</p>

Note

- If the power is turned off using the POWER button, the cooling fan will continue to operate (for approximately 60 seconds) while the inside of the Projector is still at a high temperature. Do not turn the MAIN POWER switch to the OFF position, disconnect the power cord plug from the wall socket or shut off the mains power supply until the cooling fan stops operating.
- When POWER is turned on, and while the LCD Projector is warming up, the "Panasonic" logo will be projected on the screen for approximately 30 seconds. If you press INPUT during the 30 seconds that "Panasonic" is projected, the "Panasonic" logo will disappear. During the warm up period, no other picture can be projected on the screen.
- This LCD Projector can display a favorite back-screen instead of the "Panasonic" logo. Please see "Setting the favorite back-screen" on page 29 to use this feature.
- If the POWER switch is accidentally turned off, the picture may not be projected even if the power is immediately turned back on. In this case, wait a while (approx. 60 seconds) for the lamp to cool down before turning the power back on again.
- The remote power function may cause the operation of the POWER button on the remote control to be disabled temporarily. For details about this function, refer to page 27.
- If the MAIN POWER switch has not been turned off, the Projector will still draw approximately 20 W of power, even when the POWER button has been turned off and the fan has stopped.

Screen Requirements

This Projector is used to project the image onto flat screens. However, the brightness and viewable range will vary depending on which type of screen is used.

When selecting a screen, check the characteristics of the screen to ensure that it is suitable for the intended place of use.

■ Screen characteristics (reference)

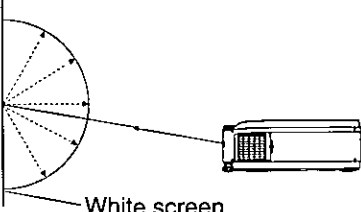
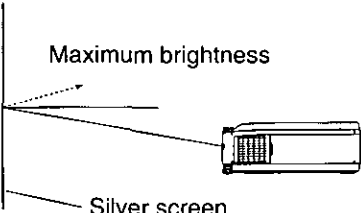
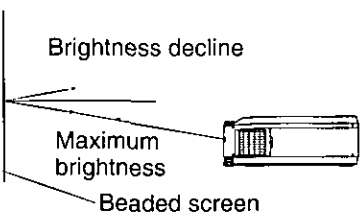
Screen type		Screen characteristics
Reflective screens	White screen	<p>This type of screen can be seen from anywhere, so there are no limits on the viewing position. However, the surrounding walls should be darkened as in a movie theater, otherwise a clear picture cannot be obtained.</p>  <p>White screen</p>
	Silver screen	<p>This type of screen gives a picture which is 2-4 times brighter than a white screen. A variety of types are available from different manufacturers, and each type has different brightness characteristics. Some also have restrictions on the possible range of viewing positions.</p> <p>* Care should be taken with screens that have a high gain, as these types of screen can cause color distortion at the left and right edges.</p> <p>* This type of screen is recommended when the Projector is suspended from the ceiling.</p>  <p>Maximum brightness</p> <p>Silver screen</p>
	Beaded screen	<p>This type of screen is similar to the silver screen, except that no color distortion occurs at the left and right edges. Moreover, most of the light is reflected at the same angle as the angle of incidence.</p> <p>* This type of screen is recommended when the Projector is placed on the floor.</p>  <p>Brightness decline</p> <p>Maximum brightness</p> <p>Beaded screen</p>
Translucent screens	Flexible translucent screen	<p>This type of screen is made of PVC (polyvinyl chloride). It has the same characteristics as silver screens, but sometimes it can have hot spots.</p>
	Rigid-type translucent screen	<p>This type of screen is made of acrylic plastic. It is extremely durable and has excellent optical characteristics. It performs in the same way as silver screens.</p>

Note

- A Polarized screen can not be use for this LCD Projector, because its polarizing effect will add to the polarization already designed into the Projector (to increase its efficiency). The resulting image will not appear in its true color.

Standard Setting-up Positions

The screen should be positioned so that it is not directly touched by sunlight or room light as this will wash out the colors of the picture making it hard to see. When possible, close all blinds, curtains, etc. and dim the lights. Also, the LCD Projector should be at a 90° angle to the screen for the best picture results. To determine the distance for the desired size, please refer to the LCD Projector/Screen Relationship Chart below.

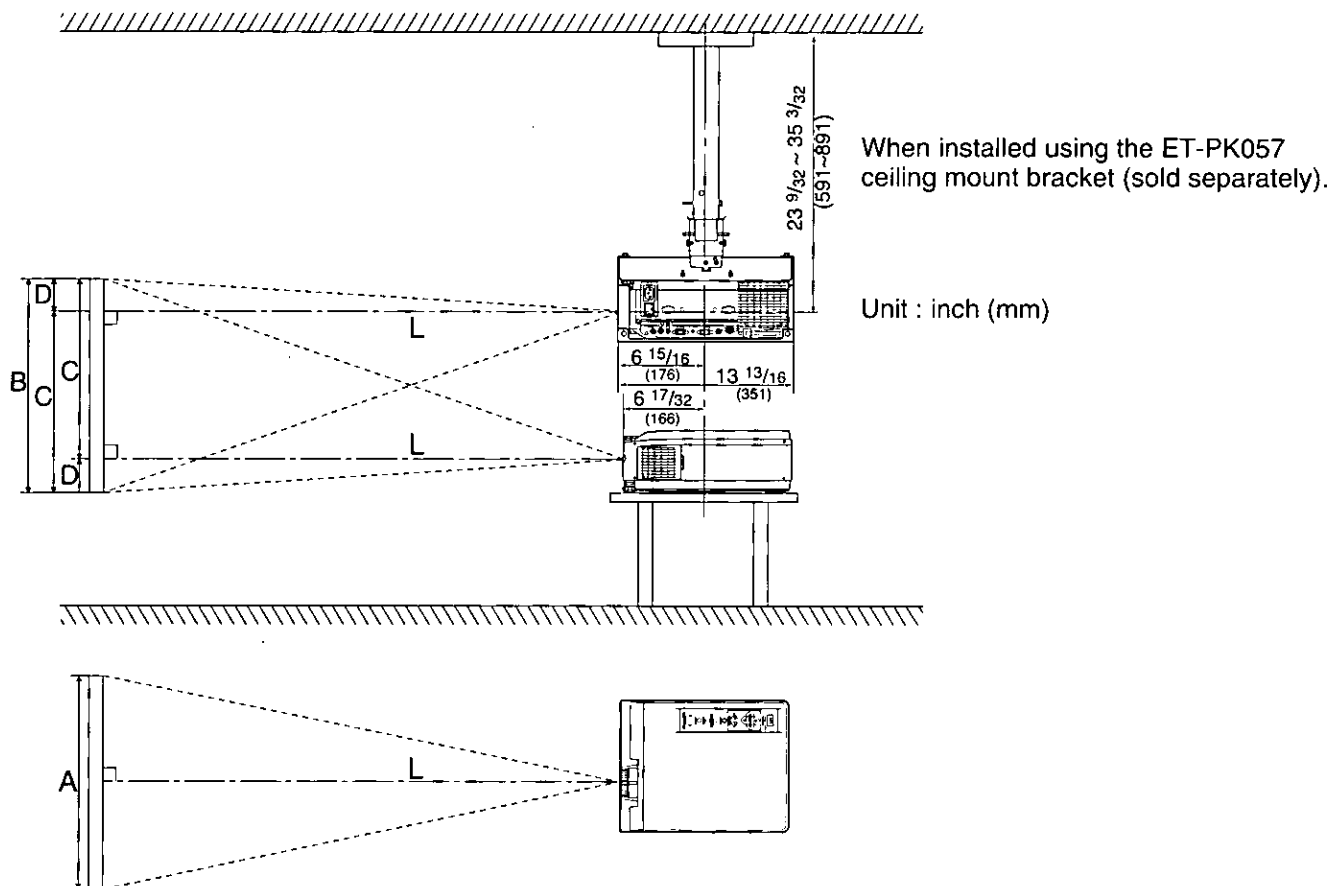

- Your LCD Projector is equipped with an image reverse feature. (See page 14.)

LCD Projector /Screen Relative Position Chart

The picture can be adjusted to the desired size within the range of the zoom lens.
(This chart is based on XGA input signal. Screen sizes will be smaller when SVGA signal is used.)

Screen size	Throw distance (L)	Measure (A)	Measure (B)	Measure (C)	Measure (D)
20 inches	2.79 ft (0.85 m)	1.33 ft (0.41 m)	1.00 ft (0.31 m)	0.86 ft (0.26 m)	1.7 in. (4 cm)
40 inches	4.36 - 5.74 ft (1.33-1.75 m)	2.67 ft (0.81 m)	2.00 ft (0.61 m)	1.71 ft (0.52 m)	3.4 in. (9 cm)
60 inches	6.66 - 8.69 ft (2.00 - 2.65 m)	4.00 ft (1.22 m)	3.00 ft (0.91 m)	2.57 ft (0.78 m)	5.1 in. (13 cm)
80 inches	8.96 - 11.65 ft (2.73 - 3.55 m)	5.33 ft (1.63 m)	4.00 ft (1.22 m)	3.43 ft (1.05 m)	6.9 in. (17 cm)
100 inches	11.25 - 14.60 ft (3.43 - 4.45 m)	6.67 ft (2.03 m)	5.00 ft (1.52 m)	4.29 ft (1.31 m)	8.6 in. (22 cm)
120 inches	13.55 - 17.55 ft (4.13 - 5.35 m)	8.00 ft (2.44 m)	6.00 ft (1.83 m)	5.14 ft (1.57 m)	10.3 in. (26 cm)
150 inches	16.99 - 21.98 ft (5.18 - 6.70 m)	10.00 ft (3.05 m)	7.50 ft (2.29 m)	6.43 ft (1.96 m)	12.9 in. (33 cm)
200 inches	22.74 - 29.36 ft (6.93 - 8.85 m)	13.33 ft (4.06 m)	10.00 ft (3.05 m)	8.57 ft (2.61 m)	17.1 in. (44 cm)
250 inches	28.48 - 36.75 ft (8.68 - 11.20 m)	16.67 ft (5.08 m)	12.50 ft (3.81 m)	10.71 ft (3.27 m)	21.4 in. (54 cm)
300 inches	34.22 - 44.13 ft (10.43 - 13.45 m)	20.00 ft (6.10 m)	15.00 ft (4.57 m)	12.86 ft (3.92 m)	25.7 in. (65 cm)

- If the LCD Projector and the screen are not properly placed, the picture will be distorted producing a keystone image as shown at right.

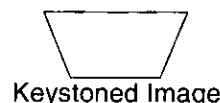

Caution: When you set up the LCD Projector

- Do not place it in humid or dusty places, or places where the air is sooty or full of cigarette smoke. If the lens, mirror, or other optical components become dirty, the picture will blur or darken, making viewing difficult.
- Do not expose to extreme heat or cold. Operating temperature: 5°C – 40°C (41°F – 104°F)

■ Setting the Projector up horizontally

If the Projector is not set up so that it is horizontal, it will not be possible to obtain a distortion-free picture. If placing the Projector on top of a table or similar surface, carry out the following procedure below to ensure that no distortion of the picture occurs.

• Adjustment procedure

- 1** Lift the front of the Projector until the Projector as a whole is horizontal. While holding it in this position, press the adjuster buttons under the sides of the Projector (1 each at left and right). When the buttons are pressed, the left and right adjustable legs will drop down until they reach the setting-up surface.

Note

- Do not release the buttons until both legs have reached the setting-up surface.

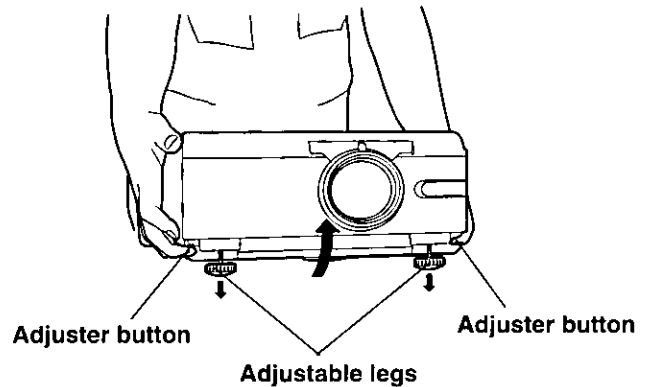

- 2** Release the adjuster buttons. (The adjustable legs will lock as soon as the buttons are released.)

- 3** Turn the adjustable legs by hand in either direction to make fine adjustments to the level of the Projector so that the Projector is perfectly horizontal.

Note

- The legs can be extended by up to 52 mm. If you try to extend them any further than this, they will merely spin freely.

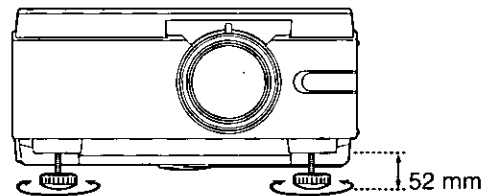

■ Retracting the adjustable legs

After lifting the front of the Projector slightly, press and hold the adjuster buttons and then gently lower the Projector.

Note

- Be sure to support the Projector firmly while pressing the adjuster buttons. If the adjuster buttons are pressed without supporting the Projector, the adjustable legs will suddenly unlock and the Projector will fall down, which could catch your fingers and damage the Projector.

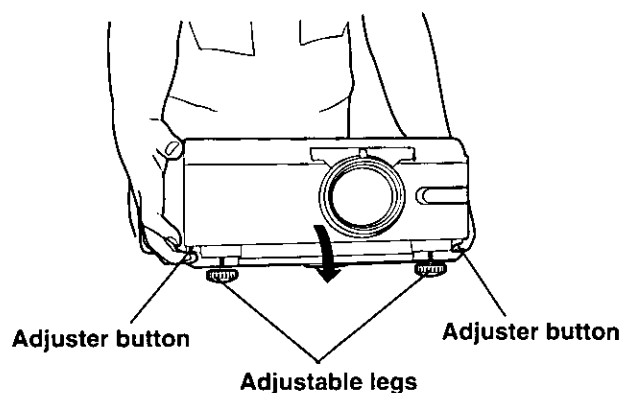

Adjusting the Lens

If the LCD Projector is not set up so that it is horizontal, it will not be possible to obtain a distortion-free picture. Turn the adjusters in either direction to make fine adjustments to the level of the Projector so that the Projector is perfectly horizontal.

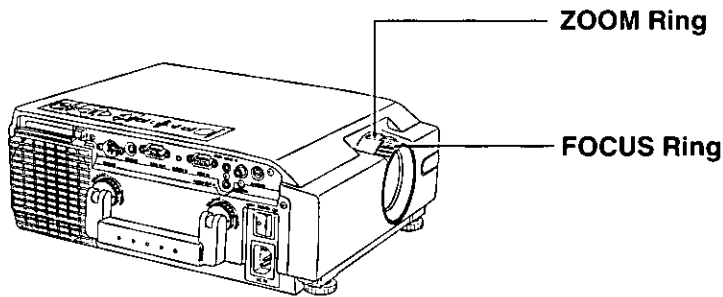

- 1 Turn the ZOOM Ring** to adjust the size of the picture.
 - For a larger picture, turn the ring to the right.
 - For a smaller picture, turn the ring to the left.

- 2 Turn the FOCUS Ring** to adjust the focus of the picture.
 - Turn the ring to the right or left until the picture is at the optimum focus.

- 3 Turn the ZOOM Ring again** to adjust the size of the picture.
 - When you turn the FOCUS Ring, the size of the picture changes.

Displaying the on-screen menu screens

If you want to set up the LCD Projector or adjust the projected picture, press MENU on the LCD Projector or remote control to display the on-screen menu screens shown below.

(LCD Projector)

(Remote Control)

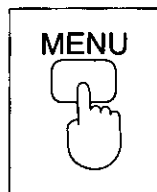
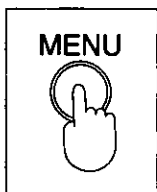

Press **MENU** when the on-screen displays disappear, and the menu screen will be displayed as shown below.

Note

- Each press of MENU while the adjust or setup screens are displayed, changes the screen to the previous menu screens shown below.

RGB Input Signal

```

----- MENU -----
▶RGB ADJUST
RGB SYNC MENU
SET UP PROJECTOR
LANGUAGE
 /SPRACHE /LANGUE
 /IDIOMA /LINGUA
 /言語 /语言
SELECT : PUSH ▲ or ▼
SET : PUSH ◀ or ▶
END : PUSH MENU
    
```

YPBPR Input Signal

```

----- MENU -----
▶YPBPR ADJUST
YPBPR SYNC MENU
SET UP PROJECTOR
LANGUAGE
 /SPRACHE /LANGUE
 /IDIOMA /LINGUA
 /言語 /语言
SELECT : PUSH ▲ or ▼
SET : PUSH ◀ or ▶
END : PUSH MENU
    
```

S-VIDEO/VIDEO Input Signal

```

----- MENU -----
▶VIDEO ADJUST
SET UP PROJECTOR
VIDEO SYSTEM
LANGUAGE
 /SPRACHE /LANGUE
 /IDIOMA /LINGUA
 /言語 /语言
SELECT : PUSH ▲ or ▼
SET : PUSH ◀ or ▶
END : PUSH MENU
    
```

PC-CARD Input Signal

```

----- MENU -----
▶PC-CARD ADJUST
SET UP PC-CARD
SET UP PROJECTOR
LANGUAGE
 /SPRACHE /LANGUE
 /IDIOMA /LINGUA
 /言語 /语言
SELECT : PUSH ▲ or ▼
SET : PUSH ◀ or ▶
END : PUSH MENU
    
```

Setting-up Positions and Changing the Projection-Mode

The projection mode used by the Projector can be changed in accordance with the setting-up position. Including ceiling mounting; you may select from four direction types. At the time of shipment from the factory, the Projector is set to the No.1 "FLOOR/FRONT" projection mode, but this can be changed if required.

1 Press MENU to display the menu.

2 Press \wedge or \vee to select "SET UP PROJECTOR", and then **\leftarrow or \rightarrow** to display the screen.

3 Press \wedge or \vee to select "SET UP DISPLAY", and then **\leftarrow or \rightarrow** to display the screen.

4 Press \wedge or \vee to select "PROJECTION MODE", and then **\leftarrow or \rightarrow** to select projecting mode from 1 to 4.

- Select 1 FLOOR/FRONT (Factory setting)
- Select 2 FLOOR/REAR (Right and Left displays in reverse)
- Select 3 CEILING/REAR (Up and Down displays in reverse)
- Select 4 CEILING/FRONT (Up and Down/Right and Left reverse display.)

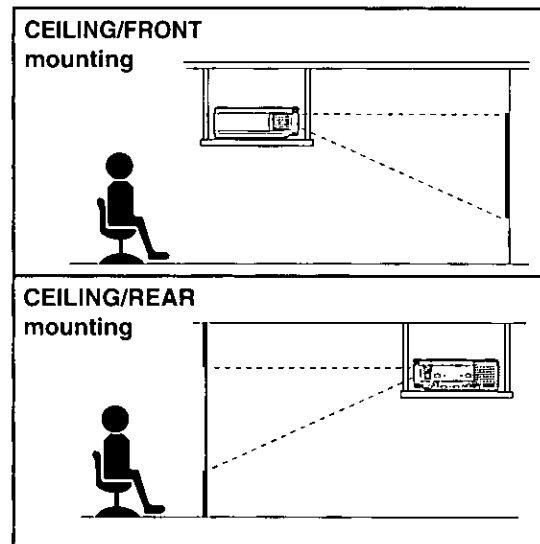
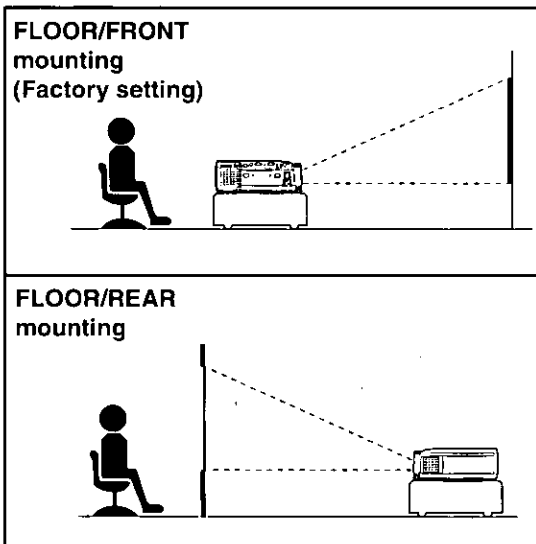
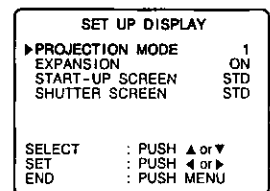
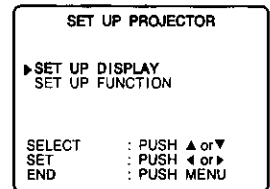
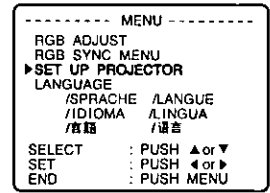

Note

- If the lettering on the screen is projected backwards or upside down, it is because the wrong mode have been selected.
- Press MENU to remove the setup screen and menu.

Setting the Screen Type

This LCD Projector is compatible with wide screen (16:9 ratio). If a wide screen is used and you set the screen type to 16:9 in order to project a wide (16:9) picture to fill the entire screen, pictures are correctly projected within the screen when projecting older (normal) 4:3 ratio pictures.

Please follow the instructions below to set the screen type.

The procedure and on-screen displays below are based on S-Video/Video as the input signal.

1 Press **MENU** to display the menu.

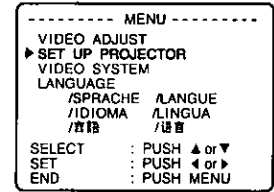

2 Press **▲** or **▼** to select "SET UP PROJECTOR", and then **<** or **>** to display the screen.

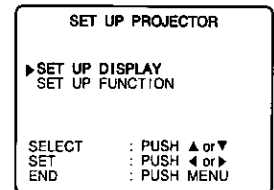

3 Press **▲** or **▼** to select "SET UP DISPLAY", and then **<** or **>** to display the screen.

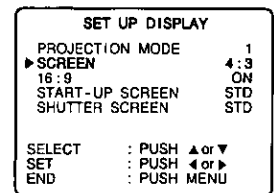

4 Press **▲** or **▼** to select "SCREEN", and then **<** or **>** to change the screen type.

- The 4:3 type screen is set at the factory.

Note

- Press **MENU** to remove the setup screen and menu.

	Wide Function (OFF)	Wide Function (ON)
4:3 Type Screen		
16:9 Type Screen		

Note

- Please refer to "Changing to 16:9 (wide) screen format" on page 28 if you change to the wide (16:9) screen and project pictures.

Basic LCD Projector Operation

■ Changing the input signal

Press the INPUT button

(LCD Projector) (Remote Control)

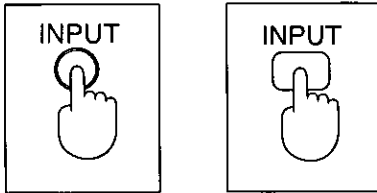

The input source for picture signals and the corresponding audio signals can be changed by pressing the INPUT buttons on the Projector operating panel or on the remote control. In addition, the name of the input source selected will be displayed on the screen for approximately 5 seconds.

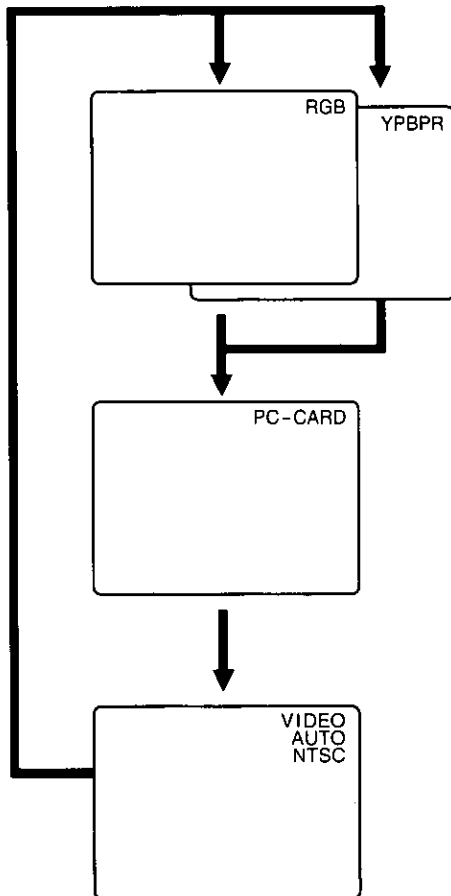

The signal from the source which is connected to the RGB/YPBPR connector is projected.

This terminal accepts input of RGB input signals from a personal computer and DTV Format signals (RGB, YPBPR) from a DVD or a digital broadcast. No monitor or Projector can automatically decide whether a Component signal is the RGB-type or the YPBPR-type. So, you will have to select either RGB or YPBPR manually.

The signal from the source which is connected to the PC-CARD IN connector is projected.

The signal from the source which is connected to the S-VIDEO IN connector or VIDEO IN connector is projected.

If cables are connected to both connectors, the S-VIDEO signal will be selected automatically. (The S-VIDEO signal has priority.)

Note

- The LCD Projector is factory set so that the proper input must be selected manually with the INPUT button. For automatic input selection according to input signal, refer to "Using Auto Input Select Feature" on page 27.
- To turn off the input signal on-screen display, please see "Turning off the input signal display" on page 27.
- If you would like to project the VIDEO signals being input to the VIDEO IN connector, do not connect any cables to the S-VIDEO IN connector.
- There is only one audio system circuit provided for the VIDEO AUDIO IN terminals for S-VIDEO and VIDEO signals. Because of this, if using both S-VIDEO signals and VIDEO signals, it will be necessary to change over the connectors.
- The LCD Projector is shipped from the factory with the system format selection function set to "AUTO (NTSC, PAL, SECAM)". If the correct picture is not projected when VIDEO signal is input and it is necessary to change the input to match the input signal, refer to "S-VIDEO/VIDEO Signal Format Selection" on page 19.
- Please refer to page 34 to change the setting if you change the signal input to the RGB/YPBPR connector.
- When RGB signal is input, please input the registered signals found on page 17.

■ RGB Signals that can be Input

The projection mode will be matched automatically to one of the modes which have been pre-set inside the Projector.

If a signal which differs greatly from any of the types listed below is input, the picture image may not be displayed correctly, or a blue background may be displayed.

Display mode name		Signal data			
		No. of dots	Horizontal frequency (kHz)	Vertical frequency (Hz)	Dot clock frequency (MHz)
Personal Computer Signals	VGA400 (70 Hz)	640 X 400	31.47	70.08	25.175
	VGA480 (60 Hz)	640 X 480	31.47	59.94	25.175
	Macintosh 13"	640 X 480	35.00	66.67	30.241
	VESA400 (85 Hz)	640 X 400	37.86	85.08	31.500
	VESA480 (72 Hz)	640 X 480	37.86	72.81	31.500
	VESA480 (75 Hz)	640 X 480	37.50	75.00	31.500
	VESA480 (85 Hz)	640 X 480	43.27	85.01	36.000
	SVGA (56 Hz)	800 X 600	35.16	56.25	36.000
	SVGA (60 Hz)	800 X 600	37.88	60.32	40.000
	SVGA (72 Hz)	800 X 600	48.08	72.19	50.000
	SVGA (75 Hz)	800 X 600	46.88	75.00	49.500
	SVGA (85 Hz)	800 X 600	53.67	85.06	56.250
	XGA (60 Hz)	1024 X 768	48.36	60.00	65.000
	XGA (70 Hz)	1024 X 768	56.48	70.07	75.000
	XGA (75 Hz)	1024 X 768	60.02	75.03	78.750
	Macintosh 16"	832 X 624	49.73	74.55	57.283
	Macintosh 19"	1024 X 768	60.24	74.93	80.000
	XGA (85 Hz)	1024 x 768	68.68	85.00	94.500
	*1152 X 864 (60 Hz)	1152 X 864	54.05	60.06	80.000
	*1152 X 864 (70 Hz)	1152 X 864	63.85	70.01	94.500
	*1152 X 864 (75 Hz)	1152 X 864	67.50	75.00	80.000
	*1152 X 864 (85 Hz)	1152 X 864	77.09	85.00	94.500
	*Macintosh 21"	1152 X 870	68.68	75.06	100.000
	*1280 X 960 (60 Hz)	1280 X 960	60.00	60.00	108.000
	*1280 X 960 (75 Hz)	1280 X 960	75.00	75.00	126.000
	*1280 X 1024 (60Hz)	1280 X 1024	63.98	60.02	108.000
*1280 X 1024 (75Hz)	1280 X 1024	79.98	75.03	135.000	
DTV Format Signals	480i	664 X 485	15.73	29.97	12.650
	480p	720 X 483	31.47	59.94	27.000
	* 720p	1280 X 720	45.00	60.00	74.250
	*1080i	1920 X 1080	33.75	30.00	74.250
	625i	756 X 576	15.63	25.00	14.500

* Changing the number of dots to be displayed to within 1024 X 768 may cause a portion of information to be omitted, or the image quality to be degraded.

Note

- DTV Format Signals are picture signals from a DVD or a digital broadcast.

■ Component Signals (YPbPr) that can be Input

Display mode name		Signal data			
		No. of dots	Horizontal frequency (kHz)	Vertical frequency (Hz)	Dot clock frequency (MHz)
DTV format signals	480i	664 X 485	15.73	29.97	12.650
	480p	720 X 483	31.47	59.94	27.000
	* 720p	1280 X 720	45.00	60.00	74.250
	*1080i	1920 X 1080	33.75	30.00	74.250
	625i	756 X 576	15.63	25.00	14.500

* Changing the number of dots to be displayed to within 1024 X 768 may cause a portion of information to be omitted, or the image quality to be degraded.

Note

- DTV Format Signals are picture signals from a DVD or a digital broadcast.

■ Blue Screen with No Input Signal

The LCD Projector is equipped with an internal Blue Screen function which turns the screen blue when the video or computer equipment connected to the input jack is turned off, or when there is nothing connected to the input jack.

- If the power is turned on when no input signal is input to the LCD Projector, the screen will turn blue.
The "FOCUS" overlay appears only until the video or computer equipment is connected to the input jack and turned on. If no input signal is received (the screen is blue) for 15 minutes, the lamp will turn off automatically.
- The display at right will appear when the RGB input is within the LCD Projector's frequency range, but is not one of the LCD Projector's programmed formats. (See pages 17, 18.)
- Should an RGB signal be input which is out of the LCD Projector's frequency range, no indication will be present.

[5 Minutes before power is shut off.]

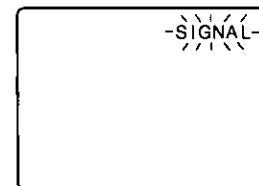
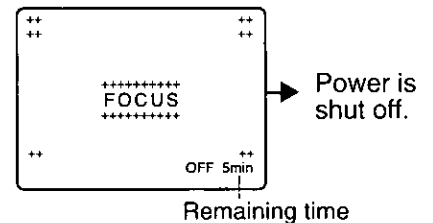

■ S-VIDEO/VIDEO Signal Format Selection

If the correct signal format is not selected and the picture does not appear normal when VIDEO or S-VIDEO signals are being input, select the format by the following procedure. This function is set to "AUTO (NTSC, PAL, SECAM)" at the time of shipment from the factory, so that the Projector can normally be used with this setting left as it is in the Latin America area.

1 Press MENU to display the menu.

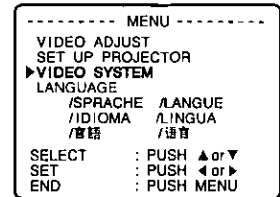

2 Press ▲ or ▼ to select "VIDEO SYSTEM", and then < or > to display the screen.

3 Press ▲ or ▼ to switch the setting to "AUTO (NTSC, PAL-M/N)", "AUTO (NTSC, PAL, SECAM)", "NTSC", "NTSC"4.43", "PAL", "PAL-M", "PAL-N" or "SECAM" until a normal picture is obtained.

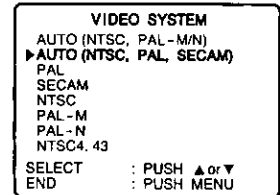

	Horizontal scanning frequency (kHz)	Vertical scanning frequency (Hz)	Color sub-carrier frequency (MHz)
AUTO (NTSC, PAL-M/N)	"NTSC", "PAL-M", or "PAL-N" is selected automatically.		
AUTO (NTSC, PAL, SECAM)	"NTSC", "NTSC4.43", "PAL" or "SECAM" is selected automatically.		
NTSC	15.75	60.00	3.58
NTSC4.43			4.43
PAL-M			3.58
PAL	15.63	50.00	4.43
PAL-N			3.58
SECAM			4.25 or 4.41

Note

- If using a signal source with poor picture quality, such as a dubbed tape, it may not be possible to get the picture to display properly.
- NTSC and PAL-M have the same scanning frequencies and color sub-carrier frequencies, but they have different color modulation methods. Because of this, if the incorrect setting is selected, color pictures may appear in black-and-white.
- The video system screen is not displayed with no S-VIDEO/VIDEO input signal.
- Press MENU to remove the setup screen and menu.

■ Adjusting the Volume

The volume can be adjusted using the VOLUME +/- on the LCD Projector or remote control.

(LCD Projector) (Remote Control)

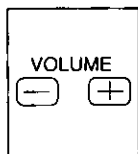
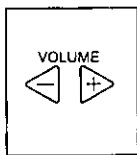

- Press **VOLUME +** to turn the volume high.
- Press **VOLUME -** to turn the volume low.

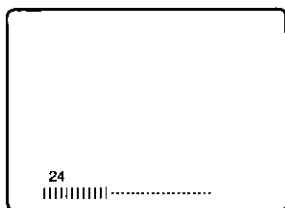

Note

- The volume level will remain displayed on the screen for approximately 5 seconds.

■ Turning off the sound

If the MUTE button on the remote control is pressed, "MUTE" will be displayed on the screen as shown in the illustration below and the sound will be muted. If the MUTE button is pressed once more, the on-screen display will be cleared and the normal sound volume will be restored.

(Remote Control)

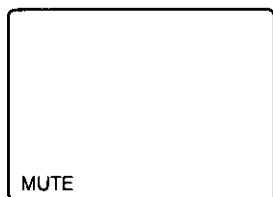
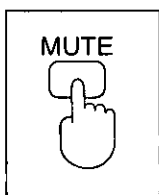

Note

- If the Power supply is turned off or either of the VOLUME +/- buttons is pressed, the mute setting will be canceled.

■ Turning off the Picture and Sound at the same time

When SHUTTER is pressed on the remote control the picture and sound turns off and the screen goes black. Press SHUTTER again to resume picture and sound. You can display a favorite image instead of the black back-screen. Please refer to "Setting the favorite back-screen" on page 29 to use this feature.

(Remote Control)

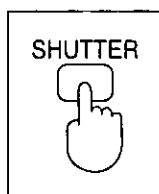

Note

- When the screen goes black, the picture will not be shown on the screen. However, the picture continues to be sent from the Personal Computer or video source.

■ Freezing the picture

Projection can be switched between a frozen (still) picture and a moving picture each time the FREEZE button on the remote control is displayed. Press FREEZE again to resume motion.

(Remote Control)

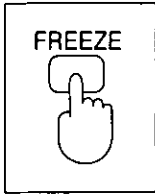

Note

- The sound is muted while the picture frozen.

■ Returning adjustment values to the factory default settings (standard values)

If you press < and > at the same time on the remote control while the RGB (YPbPr), PC-Card or VIDEO adjust screen or an individual adjustment screen is being displayed, you can return the adjustment value to the standard values set at the factory.

(LCD Projector)

(Remote Control)

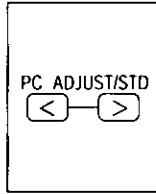
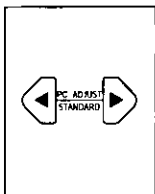

VIDEO ADJUST (1 / 2)	MODE1
▶ COLOR 20+..-
TINT 0+..-
BRIGHTNESS 10+..-
PICTURE 0+..-
SHARPNESS 0+..-
STANDARD : PUSH ◀ and ▶	
SELECT : PUSH ▲ or ▼	
SET : PUSH ◀ or ▶	
END : PUSH MENU	

Press < and > at the same time while the RGB (YPbPr), PC-Card or VIDEO adjust screen is displayed.

...All items displayed on-screen will be returned to their standard values.

VIDEO ADJUST	MODE3
COLOR +20+..-

Press < and > at the same time while an individual adjustment screen is being displayed.

...Only the item being adjusted will be returned to its standard value.

Selecting the Picture Mode

In order to obtain better picture quality, three types of picture mode are available for RGB signals, YPBPR signals (Component signals), S-VIDEO/VIDEO signals and PC-Card signals. The three picture mode types are set to the same setting at the factory.

Please refer to "Adjusting the Picture to the Desired Setting" on page 23, and then properly adjust each mode to the environment or picture.

Changing the Picture Mode

You can change the picture mode by pressing MODE on the LCD Projector or remote control.

(LCD Projector) (Remote Control)

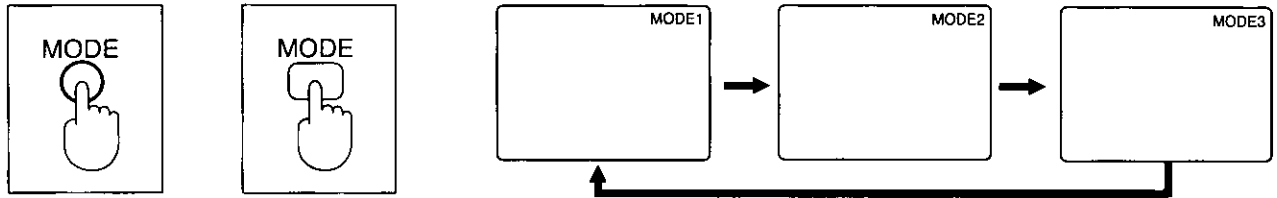

Note

- Press MODE to display the current mode. From the second press, you can change the mode.
- If the button is not pressed for 5 seconds, the mode on-screen display will disappear.

Changing the Mode While the VIDEO ADJUST Screen

The procedure and on-screen displays below are based on S-VIDEO/VIDEO as the input signal.

1 Press MENU to display the menu.

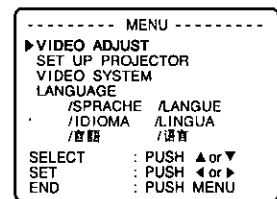

2 Press V or ^ to select "VIDEO ADJUST", and then < or > to display the screen.

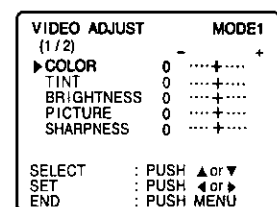

3 Press MODE to change the mode.

- Each press of MODE will change the mode as shown below.

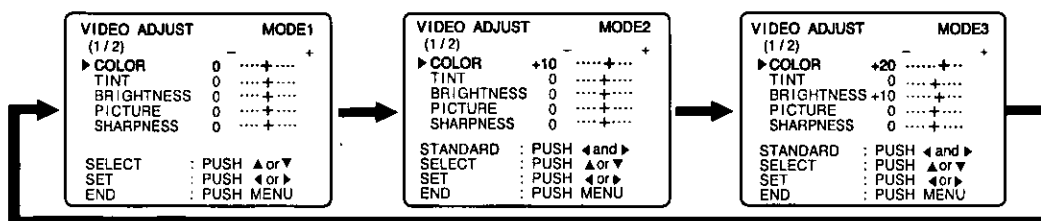

Note

- Press MENU to remove the setup screen and menu.

Adjusting the Picture to the Desired Setting

To obtain better picture quality, use the MODE button described on page 22 and adjust each of the selected modes to the desired picture. The items which can be adjusted will vary depending on the type of input signal. The adjustment procedure below describes the on-screen displays when the S-VIDEO signal or the VIDEO signal is being projected.

1 Press MENU to display the menu.

2 Press V or Λ to select "VIDEO ADJUST", and then < or > to display the screen.

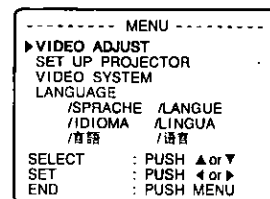

3 Press V or Λ to select "COLOR".

Note

- (1/2) or (2/2) displayed under "VIDEO ADJUST" indicates that the first or second of two setting screens is displayed.
- Press Λ in the "COLOR" item or V in the "SHARPNESS" item to display the sub color screen and image quality screen. You can adjust the white balance in the sub color adjust screen. (see page 24.)
- You can select NATURAL or DYNAMIC image quality in the image quality screen.

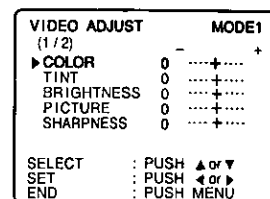

4 Press < or > to display the COLOR individual adjustment screen.

5 Press < or > to adjust the color. The current setting will be displayed on the screen by numerals and a bar.

Note

- Depending on the adjustment item, the adjust procedure and adjustment will vary. Please refer to the chart below.

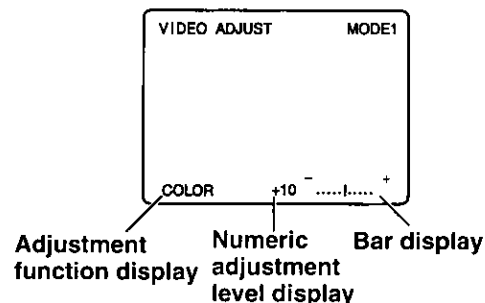

Adjustment item	Button	Adjustment Details	Adjustment Range	Remarks
COLOR	Press > button.	The color becomes deeper.	Max. value 30	YPbPr, S-VIDEO/ VIDEO only
	Press < button.	The color becomes paler.	Min. value -30	
TINT	Press > button.	Flesh tones become greenish.	Max. value 40	YPbPr, NTSC/NTSC 4.43 (S-VIDEO/ VIDEO) only
	Press < button.	Flesh tones become reddish.	Min. value -40	
BRIGHTNESS	Press > button.	The screen becomes brighter.	Max. value 30	
	Press < button.	The screen becomes darker.	Min. value -30	
PICTURE	Press > button.	Only the Highlights of the image become brighter, adding Contrast.	Max. value 30	
	Press < button.	The Highlights become less bright, diminishing Contrast.	Min. value -30	
SHARPNESS	Press > button.	The picture quality becomes sharper.	Max. value 20	YPbPr, S-VIDEO/ VIDEO only
	Press < button.	The picture quality becomes softer.	Min. value -20	

Note

- The last adjustment condition is saved and will not be erased even if the power is turned off.
- Press MENU to remove the setup screen and menu.
- If < and > are pressed together while the video adjust screen or individual adjustment screen is displayed, the adjustment condition of the adjust items currently displayed on-screen will return to the factory setting.
- The different adjustment condition cannot be saved for S-VIDEO and VIDEO.

Adjusting the White Balance

The picture may become over-saturated with red or blue color, and the white color may not be at the desired degree of whiteness. In such cases, adjust the white balance by the following procedure.

■ Adjustment procedure (for white balance adjustment of the red component)

1 Press MENU to display the menu.

2 Press \wedge or \vee to select "RGB ADJUST", and **\leftarrow or \rightarrow** to display the screen.

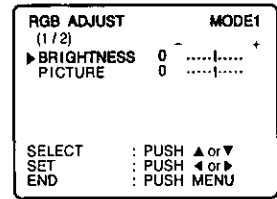

Note

- (1/2) or (2/2) displayed under "RGB ADJUST" indicates that the first or second of two setting screens is displayed.

3 Press \wedge or \vee to select "R LEVEL".

Note

- Press \wedge in the "BRIGHTNESS" item or \vee in the "PICTURE" item to display the color adjust screen (2/2).
- Display the sub color adjust screen when you input the S-VIDEO/VIDEO, YPBPR (Component signals) input signals.

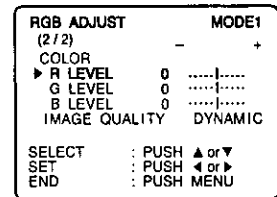

4 Press \leftarrow or \rightarrow to display the R LEVEL individual adjustment screen.

5 Press \leftarrow or \rightarrow to adjust the R LEVEL setting.

- The current setting will be displayed on the screen by numerals and a bar.

Note

- Depending on the adjustment item, the adjust procedure and adjustment will vary. Please refer to the chart below.

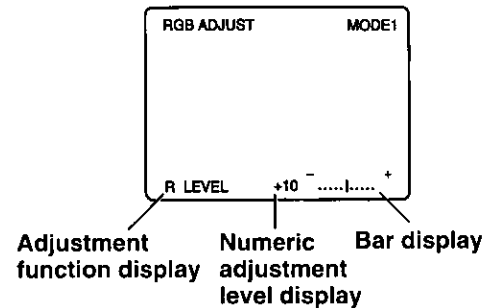

Adjustment item	Button	Adjustment Details	Adjustment Range
R LEVEL	Press > button.	The red component becomes stronger.	Max. value 30 Min. value -30
	Press < button.	The red component becomes weaker.	
G LEVEL	Press > button.	The green component becomes stronger.	
	Press < button.	The green component becomes weaker.	
B LEVEL	Press > button.	The blue component becomes stronger.	
	Press < button.	The blue component becomes weaker.	

Note

- Press MENU to remove the setup screen and menu.
- If < and > are pressed together while the video adjust screen or individual adjustment screen is displayed, the adjustment condition of the adjust items currently displayed on-screen will return to the factory setting.

Selecting the Image Quality

This LCD Projector can select NATURAL or DYNAMIC as the special characteristic of image quality. Follow the instructions below to select the image qualities you prefer. The procedure and on-screen displays below are based on RGB as the input signal.

1 Press MENU to display the menu.

2 Press \wedge or \vee to select "RGB ADJUST", and **\leftarrow or \rightarrow** to display the screen.

Note

- (1/2) or (2/2) displayed under "RGB ADJUST" indicates that the first or second of two setting screens is displayed.

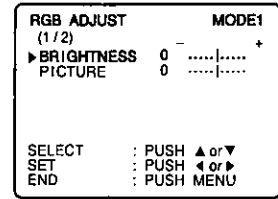

3 Press \wedge or \vee to select "IMAGE QUALITY".

Note

- You can change the setting screen by pressing \wedge when the cursor is at the first item on the screen, or \vee when the cursor is at the last item on the screen.

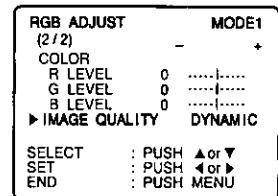

4 Press \leftarrow or \rightarrow to select the image quality.

- NATURAL is the factory S-VIDEO/VIDEO, YPBPR input signal setting.
- DYNAMIC is the factory RGB or PC-CARD input signal setting.

Using the Auto Setup Feature

When RGB input signal picture is projected from a PC (Personal Computer). It is possible to adjust the Vertical position, Horizontal position, Horizontal size and Phase automatically. (This only applies for RGB input signal from a personal computer.)

Please follow the instructions below.

1 Input the signal of the full-screen projection image from the connected device, and then project it.

2 Press \leftarrow and \rightarrow at the same time to start the Auto Setup feature.

- AUTO SETUP screen is displayed.
- AUTO SETUP screen disappears when Auto Setup feature is ended.
- Operating buttons, except the POWER button, become invalid during Auto Setup.

Note

- Adjusted settings are saved as is even if power is turned off.
- Auto Setup may not be possible if the input image is not clearly visible on the side of the screen, dark, or monotonous. In this case, refer to page 26 and adjust the image position, horizontal size, and phase.
- If a signal other than the proper RGB input signal described on page 17 is input, "SIGNAL" is displayed on-screen indicating that Auto Setup is not possible.
- Of the RGB signals that can be input described on page 17, if the signal has a Vertical dots of less than 480, "SIGNAL" is displayed indicating that Auto Setup cannot be performed.
- In some cases, Auto Setup may take about 40 seconds.

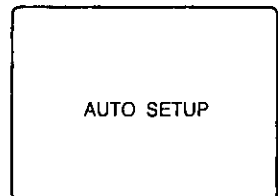

Adjusting the Image Position, Horizontal Size and Phase

Confirm the picture position, Horizontal size, and Phase. If the picture is not correctly positioned within the display area of the screen (the edge of the picture does not appear), adjust the picture position. (This only applies for RGB, YPBPR input signal.) The items which can be adjusted will vary depending on the type of input signal. The procedure and on-screen displays shown below are based on RGB as the input signal from a personal computer.

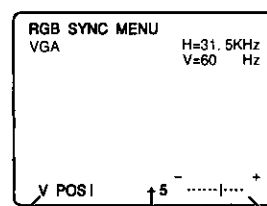
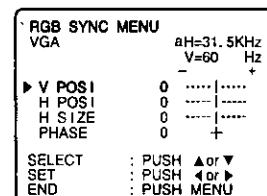
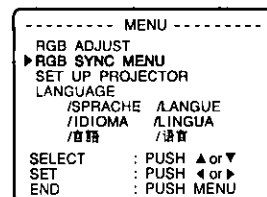

■ When adjusting the Vertical Position (V POSI)

- 1 Press **MENU** to display the menu.
- 2 Press **^** or **V** to select "RGB SYNC MENU", and **<** or **>** to display the screen.

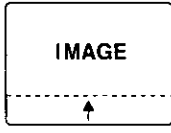
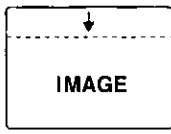
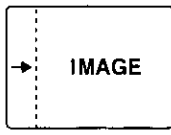

Adjustment function display Numeric adjustment level display Bar display

- Note**
- RGB signal, the name of mode, and Horizontal/Vertical scanning frequency will appear in the top corner of the screen.
- 3 Press **^** or **V** to select "V POSI".
- Note**
- When adjusting the Horizontal Position, Horizontal Size, and Phase, move the arrow to the item you want to adjust.
- 4 Press **<** or **>** to display the V POSI individual adjustment screen.
 - 5 Press **<** or **>** to adjust the V POSI setting.
 - The current setting will be displayed on the screen by numerals and a bar.
- Note**
- Depending on the adjustment item, the adjust procedure and adjustment will vary. Please refer to the chart below.

Adjustment item	Button	Adjustment Details	Adjustment Range	Note
V POSI	Press > button.	The image moves up. 	Max. value +30	
	Press < button.	The image moves down. 	Min. value -30 (The value differs with each input signal.)	
H POSI	Press > button.	The image moves to the right. 	Max. value +50	
	Press < button.	The image moves to the left. 	Min. value -50 (The value differs with each input signal.)	
H SIZE		Adjust the dot clock of the personal computer and the LCD Projector to eliminate vertical stripe, etc. from the screen.	Max. value +90 Min. value -50 (The value differs with each input signal.)	
PHASE		You can use this adjustment to eliminate the flicker (localized noise) that appears on the computer screens.	Max. value +15 Min. value 0	Only RGB input signal from a PC

- Note**
- The last adjustment condition is saved and will not be erased even if the power is turned off.
 - Press **MENU** to remove the setup screen and menu.

Using Other Useful Functions

You may use buttons on the LCD Projector or remote control for the following operations.

■ Turning off the input signal display

The function which displays the currently selected input signal on the screen can be turned off by the following procedure. The procedure and on-screen displays shown below are based on RGB as the input signal.

- 1 Press **MENU** to display the menu.
- 2 Press **▲** or **▼** to select "SET UP PROJECTOR", and then **<** or **>** to display the screen.
- 3 Press **▲** or **▼** to select "SET UP FUNCTION", and then **<** or **>** to display the screen.
- 4 Press **▲** or **▼** to select "INPUT DISP", and then **<** or **>** to select "ON" or "OFF".
 - Select "OFF" to turn off the input signal display function.
 - Select "ON" to turn the input signal display function. The input signal will be displayed each time it is changed. (This is the factory setting.)
- 5 Press **MENU** to remove the setup screen and menu.

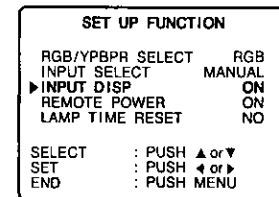
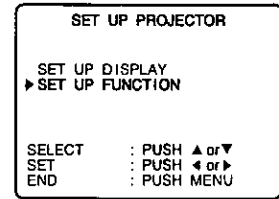

■ Disabling the POWER button on the remote control

In order to prevent the power being turned off by mistake, the POWER button on the remote control can be disabled by the following procedure. The procedure and on-screen displays shown below are based on RGB as the input signal.

- 1 Press **MENU** to display the menu.
- 2 Press **▲** or **▼** to select "SET UP PROJECTOR", and then **<** or **>** to display the screen.
- 3 Press **▲** or **▼** to select "SET UP FUNCTION", and then **<** or **>** to display the screen.
- 4 Press **▲** or **▼** to select "REMOTE POWER", and then **<** or **>** to select "ON" or "OFF".
 - Select "OFF" to disable the POWER button on the remote control.
 - Select "ON" to use the POWER button on the remote control normally. (This is the factory setting.)
- 5 Press **MENU** to remove the setup screen and menu.

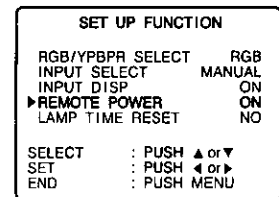
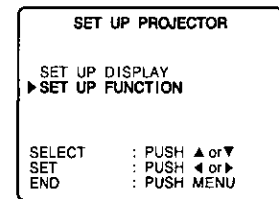

■ Using Auto Input Select Feature

The LCD Projector can change to RGB (or YPBPr) or S-VIDEO/VIDEO input signal automatically. This is convenient when operating from a distance. The procedure and on-screen displays below are based on S-VIDEO/VIDEO as the input signal.

- 1 Press **MENU** to display the menu.
- 2 Press **▲** or **▼** to select "SET UP PROJECTOR", and then **<** or **>** to display the screen.
- 3 Press **▲** or **▼** to select "SET UP FUNCTION", and then **<** or **>** to display the screen.
- 4 Press **▲** or **▼** to select "INPUT SELECT", and then **<** or **>** to select "AUTO".
 - If you select "MANUAL", you must change input manually. (This is the factory setting.)

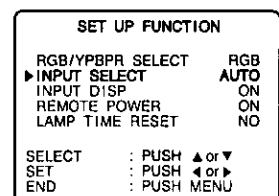
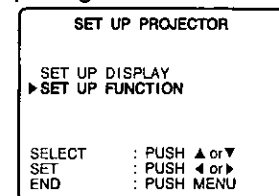

Note

- When Auto Input Select is set to "AUTO", and both RGB (or YPBPr) and S-VIDEO/VIDEO signals are input, or if neither signal is input, RGB signal input will have priority.
- When Auto Input Select is set to "AUTO", the PC-Card mode cannot be selected.
- Press MENU to remove the setup screen and menu.

■ Selecting the Language for On-Screen Displays

The language of the LCD Projector is set to English as the factory setting. To select one of seven different languages for on-screen displays, follow the instructions below.

To select displays French

- 1 Press **MENU** to display the menu.
- 2 Press **▲** or **▼** to select "LANGUAGE", and then **<** or **>** to display the screen.
- 3 Press **▲** or **▼** to select "FRANÇAIS".
 - You can select English, German, French, Spanish, Italian, Japanese and Chinese.
- 4 Press **MENU** to remove the setup screen and menu.

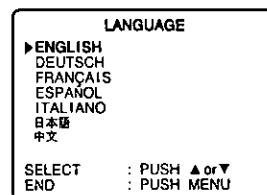
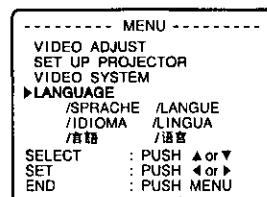

■ Canceling enlarging (scanning line conversion) function

When a S-VIDEO/VIDEO signal or a signal less than 1024 X 768 dots signals is input, the LCD Projector automatically enlarges the image to 1024 X 768 dots. This may cause picture quality degradation. For better image, select EXPANSION: OFF by the following procedure. (This only applies for RGB input signal from a personal computer and PC-Card input signal.)

- 1 Press **MENU** to display the menu.
- 2 Press **▲** or **▼** to select "SET UP PROJECTOR", and then **<** or **>** to display the screen.
- 3 Press **▲** or **▼** to select "SET UP DISPLAY", and then **<** or **>** to display the screen.
- 4 Press **▲** or **▼** to select "EXPANSION", and then **<** or **>** to select "ON" or "OFF".
 - Select "OFF" to cancel enlarge (scanning line conversion) function.
 - Select "ON" to use enlarge (scanning line conversion) function. (This is the factory setting.)
- 5 Press **MENU** to remove the setup and menu.

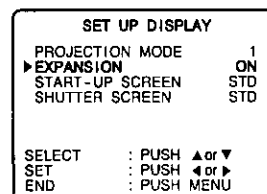
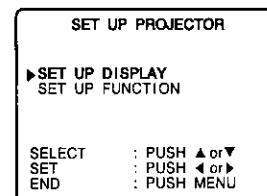

■ Changing to 16:9 (wide) screen format

When a S-VIDEO/VIDEO and DTV Format (RGB, YPBPR) signals is input, the image can be displayed in 16:9 (wide) screen by the following procedure. S-Video/ Video input is selected (page 16). (This only applies for S-VIDEO/VIDEO and DTV Format signal.)

- 1 Press **MENU** to display the menu.
- 2 Press **▲** or **▼** to select "SET UP PROJECTOR", and then **<** or **>** to display the screen.
- 3 Press **▲** or **▼** to select "SET UP DISPLAY", and then **<** or **>** to display the screen.
- 4 Press **▲** or **▼** to select "16:9", and then **<** or **>** to select "ON" or "OFF".
 - Select "OFF" to return the normal screen. (This is the factory setting.)
 - Select "ON" to display in 16:9 (wide) screen.
- 5 Press **MENU** to remove the setup and menu.

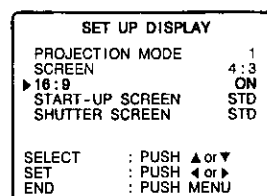
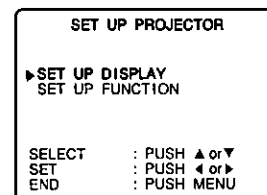

Note

• Even if the 16:9 (wide) screen feature is set to OFF, when an "S1" signal and DTV Format signal (720p, 1080i) is input, the image is automatically displayed in 16:9 (wide) screen.

■ Setting the favorite back-screen

The LCD Projector can record and store in memory the projected picture as an Original JPEG image. You can then project the Original image as a back-screen while the LCD Projector is starting-up (warming-up) and when you press SHUTTER. Please follow the instructions below. The procedure and on-screen displays shown below are based on S-VIDEO/VIDEO as the input signal.

1 Project the picture you want to record.

2 Press CAPTURE on the LCD Projector to display the capture menu.

- The screen is frozen and becomes an on-screen display.

Note

- Of the RGB signals that can be input described on page 17, if the signal has a Vertical dots of less 480, "SIGNAL" is displayed indicating that CAPTURE cannot be performed.

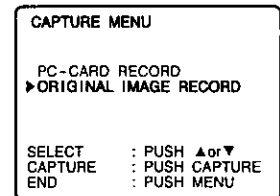

3 Press ▲ or ▼ to select "ORIGINAL IMAGE RECORD".

4 Press CAPTURE on the LCD Projector.

- The projected picture is recorded and stored as an Original image. "REC OK" is displayed when recording is completed.

Note

- If the image is captured from a moving video, the image will be frozen.
- The recorded Original image is saved as is even if power is turned off and remains in memory until another Original image is recorded.

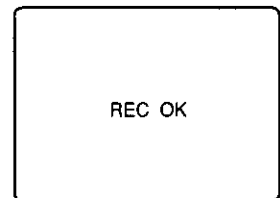

5 Press MENU to display the menu.

6 Press ▲ or ▼ to select "SET UP PROJECTOR", and then < or > to display the screen.

7 Press ▲ or ▼ to select "SET UP DISPLAY", and then < or > to display the screen.

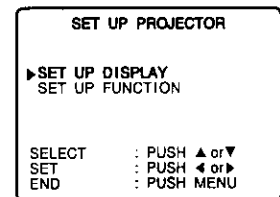

8 Press ▲ or ▼ to select "START-UP SCREEN".

- Select "SHUTTER SCREEN" if you want to set the back-screen displayed when SHUTTER is pressed.

9 Press < or > to select "ORG".

- The Original image will be projected on-screen during LCD Projector start-up.
- If you select "STD", the "Panasonic" logo will be projected on-screen during start-up. (This is factory setting.)
- If you select "STD" in the shutter screen display, the back-screen will be black when SHUTTER is pressed. (This is the factory setting.)
- The LCD Projector is shipped from the factory with the "Panasonic" logo saved as the original image.

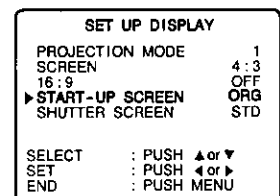

Note

- Different Original images cannot be recorded for start-up screen and shutter screen. (You can record only one Original image.)
- You can record a JPEG image from a PC-Card as the Original image. To do so, press INPUT to select PC-Card mode, and follow the instructions above. Only "ORIGINAL IMAGE RECORD" can be selected in PC-Card mode.
- If you adjust the image to be recorded, please refer to the note of "Saving the Image Data to a PC-Card (applies to LCD Projector only)" on page 37. The image may appear different after recording.
- Press MENU to remove the setup screen and menu.

System Configuration Example

Notes on system configuration

- Turn off the power supply of each system component before connecting any of the components.
- Read the instruction manual for each system component before connecting it.
- If the necessary cables for connecting any system components are not supplied with the component or available as an option, you may need to fashion a cable to suit the component concerned.
- If there is a lot of jitter in the video signal input from the video source, the picture on the screen may flicker. In such cases, it will be necessary to connect a TBC (time base corrector).
- The Projector can be connected to video signal sources which output VIDEO, S-VIDEO, analog RGB signals and Component signals (YPbPr signals).
- The Projector has built-in speaker. However, you will need to connect a separate audio system to the AUDIO OUT terminal if your needs specify high sound volumes.
- It may not be possible to connect some types of computer.

■ Example of connection to a computer

Diagram numbers correspond with numbers (see page 33).

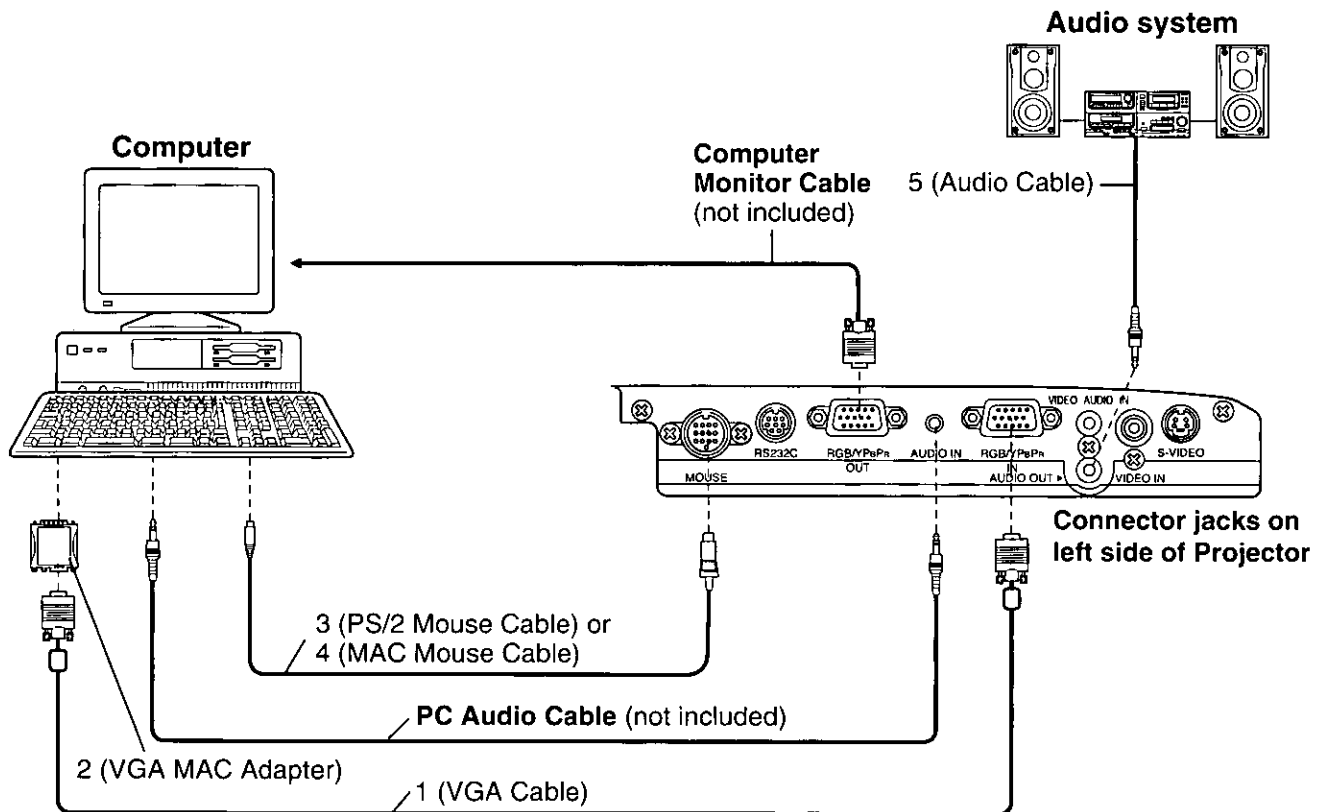

Note

- The RGB input accepts signals from VGA, SVGA, XGA, SXGA (Compression), and MAC compatible computers without the need for any additional hardware.
- Plug the VGA signal cable (supplied) correctly into the RGB/YPbPr IN terminal on the LCD Projector and the RGB signal Output terminal on your computer. Secure the plugs by tightening the thumb screws.
When connecting the LCD Projector to a Macintosh Series computer, first connect the VGA/MAC adaptor (supplied) to the RGB-signal input terminal on your computer. Then, firmly plug the VGA signal cable into both the RGB IN terminal on the LCD Projector and the VGA/MAC adaptor on the computer. Secure the plugs by tightening the thumb screws. Be sure to set the DIP switch on the VGA-MAC adaptor to your display type. (See page 31.)
- To view images simultaneously on the monitor and projection screen, connect your computer monitor to the LCD Projector's RGB OUT terminal.
- When the LCD Projector is connected to personal computer, you can use the remote control in place of the computer's mouse by attaching the Mouse cable.
- If you wish to use the wireless mouse function, turn on the main power to the Projector before turning on the personal computer.
- When connecting the LCD Projector to a compatible computer other than a VGA, SVGA, XGA, SXGA (Compression), or Macintosh series, a separate cable is needed.
- The wireless mouse feature may not be operable when using a personal computer with the Resume (last memory) feature and the feature is not reset.
- If you wish to use the plug & play function, turn on the MAIN power switch on the LCD Projector before turning on the computer.

[VGA-MAC adapter]
[Setting the DIP Switches]

RESOLUTION	DIP SWITCHES					
	1	2	3	4	5	6
*21" MULTIMODE	●	●	●	●	●	●
*17" MULTIMODE	●	●	●	●	●	●
*13" MULTIMODE	●	●	●	●	●	●
VGA/SVGA MODE						
21" 1152 X 870	●	●	●	●		
19" 1024 X 768	●	●	●	●		
16" 832 X 624	●	●				
13" 640 X 480	●	●				

LEGEND:
 * = SUPPORTS APPLE MULTIPLE SCAN SOFTWARE
 ● = ON

Find the resolution of your display type on the table shown left (also on the adaptor). Then, set each DIP switch that is indicated by a "●" mark to ON.

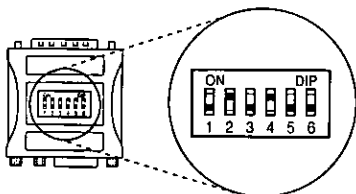

Example: If your display type is 16", set DIP switches 2 and 4 on the VGA-MAC adaptor to ON. By doing so, the signal will travel through switches 2 and 4, and Pin No. 4 to 10 as shown in the signal chart above.

■ Example of connection to audio-visual equipment

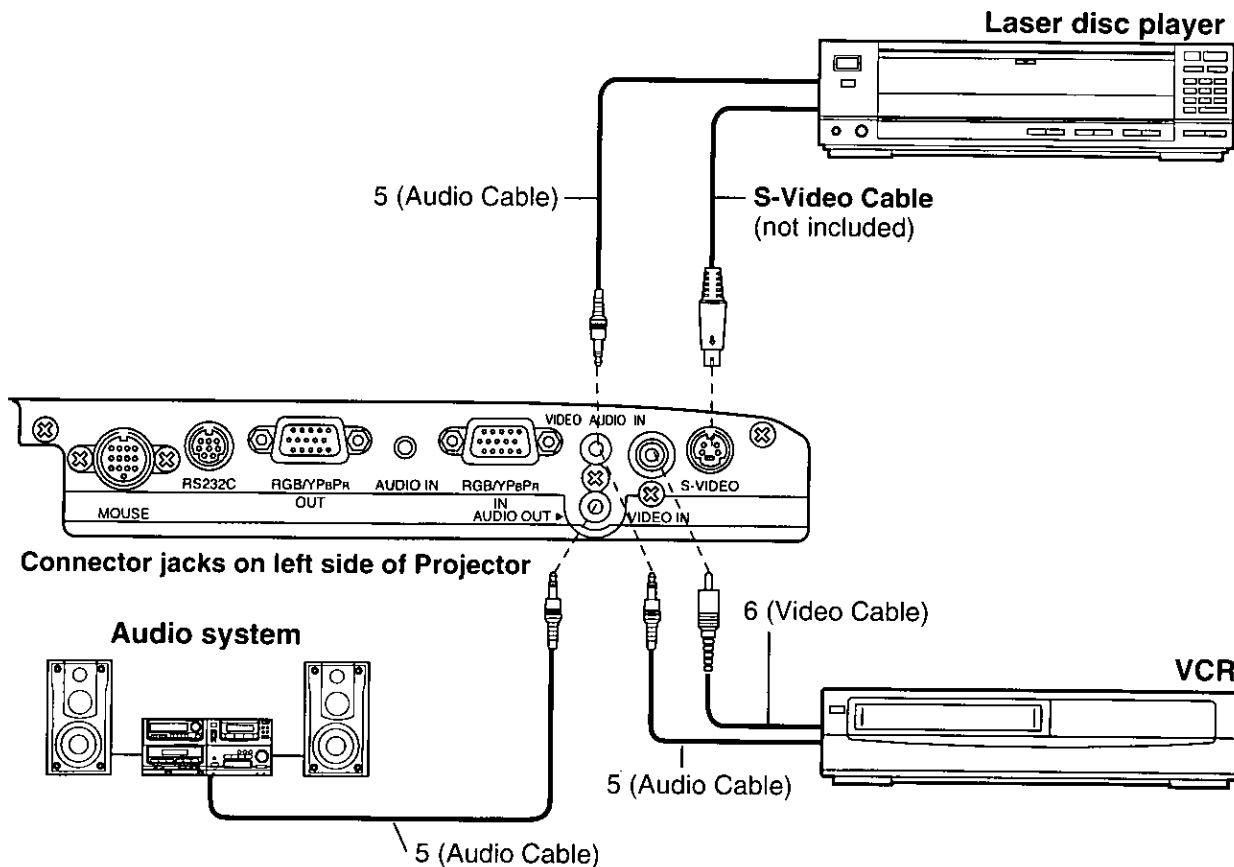

Note

- If the S-VIDEO and VIDEO IN terminals are both connected at the same time, the S-VIDEO signal input will have priority. If you wish to view the signal being input to the VIDEO IN terminal, disconnect the plug from the S-VIDEO terminal.
- Only one audio signal input system is available for the VIDEO AUDIO IN terminals for S-VIDEO/VIDEO signals, so if you wish to change the audio input source, you will need to remove and insert the appropriate plugs.
- If an audio system is connected to the AUDIO OUT terminal, muting can be controlled by the remote control which is supplied with the Projector.
- If the video signal source is connected using a cable with a BNC junction plug, use the BNC/RCA adapter (not included) to convert the pin jack.

■ Connecting D-sub 15-BNC5 (female) Adapter Cable

The Component signal (YPbPr signal) can be input and projected with this LCD Projector. Please read the operating instructions regarding the output side of the component when connecting.

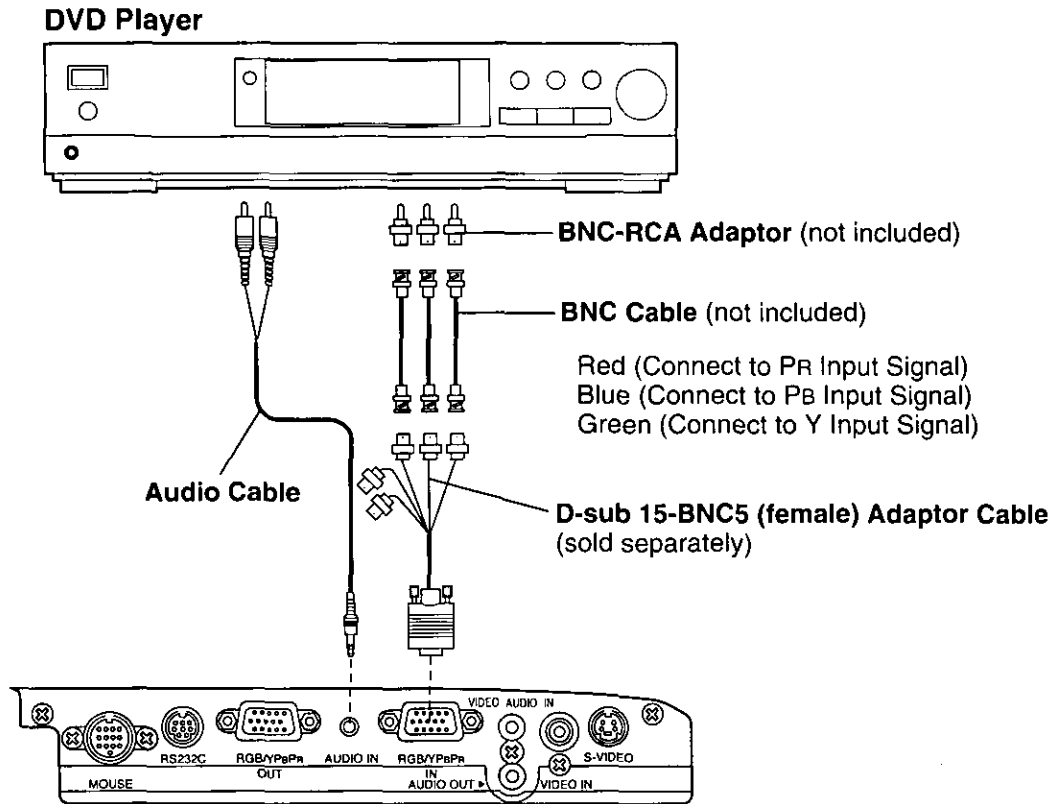

Note

- Because each Y, Pb, and PR signal is input independently, the Component signal allows for more faithful color reproduction.
- The Component signal output terminal indication will differ according to the output device (PR, Pb, Y/R-Y, B-Y, Y/Cr, Cb, Y, etc.). Please read the operating instructions included with the output device.
- You need to change the input signal setting on this LCD Projector when inputting the Component signal. In this case, please refer to page 34 to change the setting.
- D-sub 15-BNC5 (female) Adaptor Cable (sold separately) often have BNC connectors, however a DVD output device usually has RCA jacks. In this case, you will need BNC-RCA adaptors (not included).

Wireless mouse

A wireless mouse function is provided. This function lets you use the remote control to control a personal computer in place of the personal computer's mouse. This is done by connecting the projector to a personal computer using the mouse cable which is supplied with the Projector.

The LCD Projector is compatible with the following types of mouse only. Other types of mouse cannot be used. (PS/2 mouse, Macintosh mouse, Serial mouse)

Example of connection

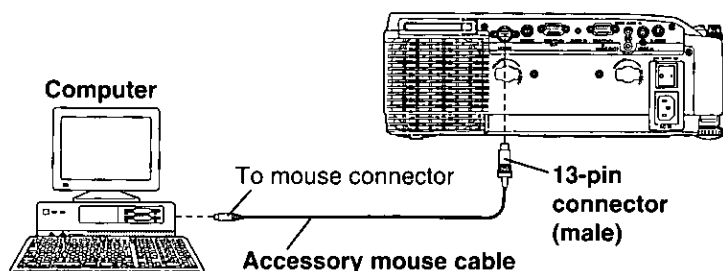

Note

- Different mouse cables are used for different types of computers. Therefore, do not use any mouse cables other than the supplied mouse cables.

< Remote Control unit >

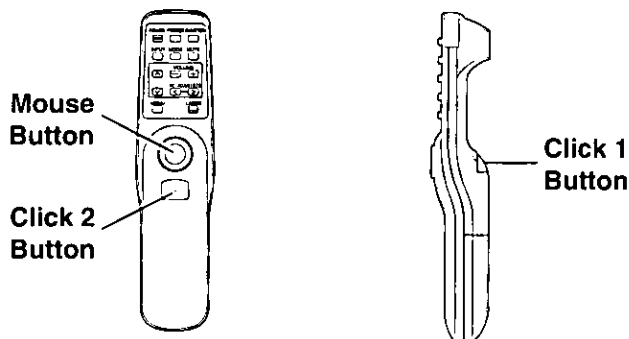

Mouse BUTTON: While gently pressing the mouse button with your thumb, push the pointer button back and forward and to the left and right. The mouse cursor will move back and forward and to the left and right on the screen.

Click 1 BUTTON: This button corresponds to the button on a single-button mouse, or to the left button on a standard mouse with two buttons.

Click 2 BUTTON: This button corresponds to the right button on a standard mouse with two buttons.

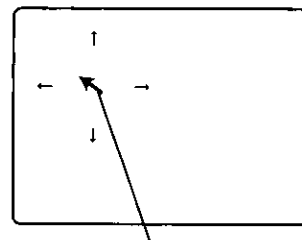

Mouse cursor

Video/ Computer Cables & Adaptors

These accessories are supplied in order to connect the LCD Projector to Computer/ AV equipment. The numbers in the left column correspond with the numbers in the connection diagrams on pages 30 - 32.

No.	CABLE/ADAPTOR	PORT				LENGTH
		Projector side		Computer/AV products side		
1	VGA Cable	D-Sub mini 15-pin (male)		D-Sub mini 15-pin (male)		6.56 ft (2.0 m)
2	VGA MAC Adaptor	D-Sub mini 15-pin (female)			MAC D-Sub 15-pin (male)	—
3	PS/2 Mouse Cable	13-pin round (male)		Din 6-pin (male)		6.56ft (2.0 m)
4	MAC Mouse Cable	13-pin round (male)		Din 4-pin (male)		6.56ft (2.0 m)
5	Audio Cable	M3 stereo mini pin (male)		RCA pin (male) X 2		4.92 ft (1.5 m)
6	Video Cable	RCA pin (male)		RCA pin (male)		4.92ft (1.5 m)

Projecting the DTV Format Signal

A DTV Format Signal, such as DVD or digital broadcast, etc. can be input and projected with this Projector. When using this function, please refer to page 32 to correctly connect to the output device of the DTV Format Signal and perform the following settings correctly.

■ Setting of the RGB/YPbPr Input Signal Selection

This LCD Projector allows input of RGB or YPbPr signal (Component input signal) to the RGB/YPbPr input terminal, but you will need to change the setting of the input signal selection manually when changing the signal to be input. If the input signal selection is not set correctly, a normal image will not be projected.

The RGB input signal is set at the factory. Please follow the instructions below to change the input signal.

1 Press MENU to display the menu.

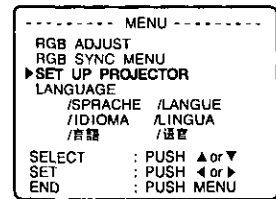

2 Press V or ^ to select "SET UP PROJECTOR", and then < or > to display the screen.

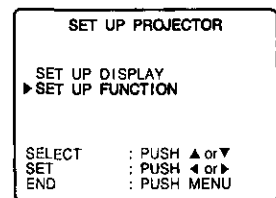

3 Press V or ^ to select "SET UP FUNCTION", and then < or > to display the screen.

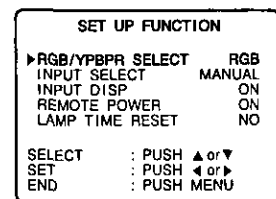

4 Press V or ^ to select "RGB/YPbPr SELECT".

5 Press < or > to change the input signal.

Note

- Press MENU to remove the setup screen and menu.

■ Setting the Color Matrix of the RGB/YPbPr Input Signal

This LCD Projector is set to select the standard color matrix automatically if you project the YPbPr input signal (Component input signal). However, if the color matrix is not match and the projected picture color is not natural, please follow the steps below to change the color matrix.

1 Press MENU to display the menu.

2 Press V or ^ to select "YPbPr ADJUST", and then < or > to display the screen.

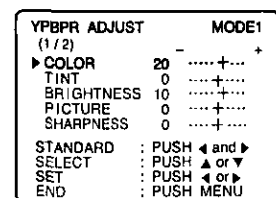

Note

- (1/2) displayed under "YPbPr ADJUST" indicates that the first or second of two setting screens (1/2) and (2/2) is displayed.

3 Press V or ^ to select "COLOR MATRIX".

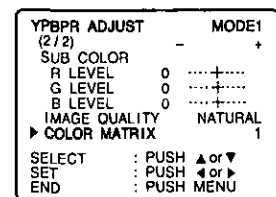

Note

- Press ^ in the "COLOR" item or V in the "SHARPNESS" item to change to the setting screen. The color matrix setting screen is displayed when the screen is changed to (2/2).

4 Press < or > to select "1" or "2".

- 1 The factory setting of the 480i, 480p, and 625i signals.
- 2 The factory setting of the 720p and 1080i signals.

Note

- While selected, if < and > are pressed together, the adjustment condition of the adjust items currently displayed on-screen will return to the factory setting.

Projecting PC-Card (ATA Flash Card) Data

Using this software, "JPEG Viewer", you can save the image displayed on the PC screen as a JPEG file, to a PC-Card (ATA Flash Card). And if you insert the PC-Card into the LCD Projector, you can project using the JPEG Image playback feature.

Please follow the below instructions to use this feature.

Note

Some ATA Flash Cards may not work with the LCD Projector. The following manufacturer PC-Cards have been verified compatible.

Panasonic, HITACHI, TDK, SanDisk, EPSON, Simple Technology

Projecting PC-Card Data

Follow the instructions below when projecting image data saved on a PC-Card. (See "JPEG Viewer Feature" on pages 40 - 44.)

1 Insert PC-Card into PC-Card Slot on the LCD Projector. Then, press **INPUT** on the LCD Projector or remote control and select PC-CARD.

- The INDEX and first image in each FOLDER are shown.

Note

- It takes a few seconds for the list of images to be displayed. (WAIT... appears.) If you made JPEG files with something other than JPEG Viewer, it may take a much longer time to display the list of images. See "When using BMP or JPEG→ JPEG Converter feature", and convert to JPEG files ideally suited to the LCD Projector.
- If you made FOLDER with something other than JPEG Viewer, FOLDER-A, FOLDER-B, will be displayed.
- "ROOT" is displayed if images corresponding to the LCD Projector are found in ROOT.
- The screen turns blue if images corresponding to the LCD Projector are not found in PC-Card.
- When you want to eject the PC-Card, press the PC-Card RELEASE button. And "NO CARD" screen is displayed.

<LCD Projector>

PC-Card
RELEASE
Button

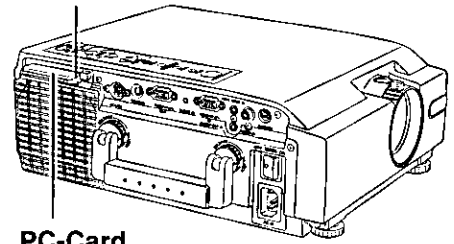

PC-Card

INDEX			
FOLDER 1			7
FOLDER 2			12
FOLDER 3			24
FOLDER 4			5
FOLDER 5			13
FOLDER 6			11

SELECT FOLDER		◀ or ▶	
TO SLIDE SHOW		VOLUME -	
TO MULTI		VOLUME +	

2 Press < or > to select FOLDER.

Press > to select the next FOLDER.

Press < to select the previous FOLDER.

- The selected FOLDER is indicated by a red arrow.
- The selected image in Folder is encircled by a bold, blue frame.

Note

- Press VOLUME- to play back the first image of the selected FOLDER.

INDEX			
FOLDER 1			7
FOLDER 2			12
▶ FOLDER 3			24
FOLDER 4			5
FOLDER 5			13
FOLDER 6			11

SELECT FOLDER		◀ or ▶	
TO SLIDE SHOW		VOLUME -	
TO MULTI		VOLUME +	

3 Press VOLUME+ to decide FOLDER.

- A list of images will be displayed.

4 Press < or > to select an image.

- The selected image is encircled by a bold, blue frame, and the FOLDER name and number is displayed.

Note

- Press V or Λ to change the selected FOLDER. And, press VOLUME- to display the INDEX.

MULTI DISP			
FOLDER 3			1/24
SELECT SLIDE		◀ or ▶	
TO SLIDE FOLDER		▲ or ▼	
TO INDEX		VOLUME -	
TO SLIDE SHOW		VOLUME +	

5 Press VOLUME+ to project the selected image.

- Press < or > to project the images one by one.
 - > : The next image is projected.
 - < : The previous image is projected.

Note

- Press VOLUME- when playing back to return the screen to the list of images.
- Press VOLUME+ during playback to display the INDEX.
- Press V or ^ during playback to display the file size (ex. 1024 x 768 dots), and the operating instructions.
- Press V or ^ again to turn off the display.

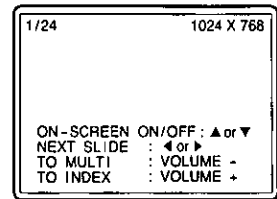

■ When using the Repeat Play

The LCD Projector can automatically play back images one by one in the selected Folder. And, you can select the length of time each image is played back.

1 Press MENU to display the menu.

2 Press V or ^ to select "SET UP PC-CARD", and < or > to display the screen.

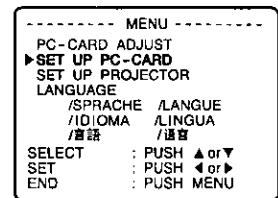

3 Press V or ^ to select "REPEAT PLAY".

4 Press < or > repeatedly to select the length of time each image is played back.

- Playback length of 5sec., 10sec., 30sec., 60sec., 120sec. can be selected.

Note

- Repeat Play can only be used in the selected Folder.
- You cannot select images while Repeat Play is in progress. Follow the instructions above to select "OFF". And then, select an image.
- You can not change the input while Repeat Play is in progress.

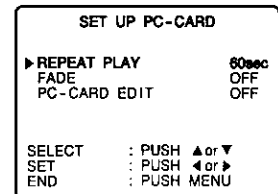
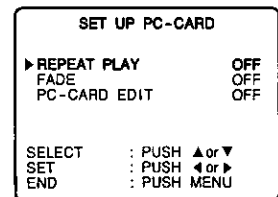

■ Using the Fade Feature

With the Fade feature, instead of instantly changing from image to image, the previous image is gradually darkened (FADE OUT), and the next image is gradually lightened (FADE IN).

Please follow the instructions below to use this feature.

1 Press MENU to display the menu.

2 Press V or ^ to select "SET UP PC-CARD", and < or > to display the screen.

3 Press V or ^ to select "FADE".

4 Press < or > to select "ON".

- If you select "OFF", the images change instantly. (This is the factory setting.)

Note

- Press MENU to remove the setup screen and menu.

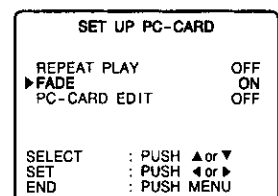
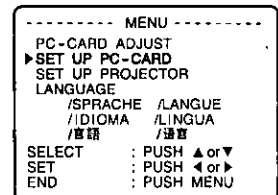

Saving the Image Data to a PC-Card (applies to LCD Projector only)

■ Saving the current projected picture to a PC-Card

When a PC-Card is inserted into the LCD Projector, the current projected picture, from RGB, YPBPR or S-VIDEO/VIDEO input signal, can be recorded to the PC-Card as a JPEG file. Follow the instructions below to set a FOLDER and record a picture.

- 1** Insert a **PC-Card** into the LCD Projector.
- 2** Press **INPUT** and select **RGB, YPBPR** or **S-VIDEO/VIDEO** input to project the images you want to record.
- 3** Press **CAPTURE** on the LCD Projector to display the **CAPTURE MENU**.
 - The screen is frozen and the screen at right will appear.

PC-Card
RELEASE
Button

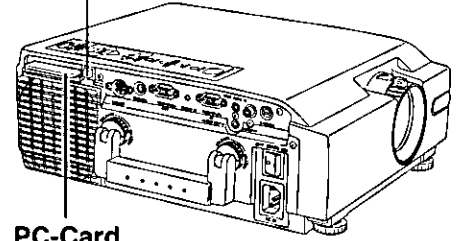

PC-Card

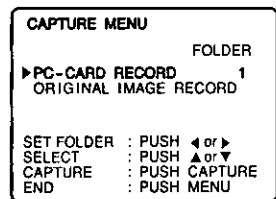

- 4** Press **V** or **Λ** to move the arrow to **PC-CARD RECORD**.

- 5** Press **<** or **>** to set the **FOLDER No.** In which pictures will be recorded.
 - Select from **FOLDER No. 1** to **16**. (No. 1 is the Default setting.)
If the PC-Card is changed, the setting reverts back to the factory setting.

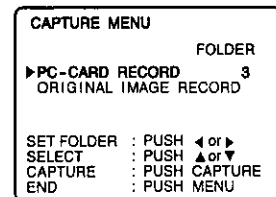

Note

- The **FOLDER No.** set above is active as long as no changes are made.
- If the PC-Card is changed, the setting reverts back to the factory setting.

- 6** Press **CAPTURE** on the LCD Projector.
 - The current projected picture is recorded in the set PC-Card **FOLDER**.
"REC OK" is displayed when recording is completed.
 - If the image is captured from a moving video, the image will be frozen.
 - **DO NOT** remove PC-Card from slot until recording is complete.

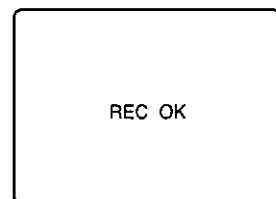

Note

- If you attempt to record an image which surpasses the Card remaining memory capacity, "REC NG" is displayed and recording will not be performed.
- The file size is saved as XGA (1024 X 768) when VGA (640 X 480) is input and when S-XGA (1280 X 1024) is input.
- When recording RGB input signal to a PC-Card, please refer to page 26 to adjust the image position, horizontal size, and phase to obtain a good projected picture. The picture is saved in the same condition it was projected.
- When adjusting the image in **VIDEO ADJUST, YPBPR ADJUST** or **RGB ADJUST**, only **BRIGHTNESS** adjust is not reflected in the recorded image. Adjust the image with **BRIGHTNESS** level at 0.
- Regarding "Selecting the Image Quality (**NATURAL/DYNAMIC**) on page 25, it is best to select the same image quality as when **PC-CARD** is the input signal. If a different image quality is selected and the picture is recorded to a PC-Card, the image appearance will differ when projected.
- Press **MENU** to remove the setup screen and menu.

■ Editing the Image File of a PC-Card

The image file saved in a PC-Card can be edited (delete, move, copy) at the LCD Projector, while watching the projected multi-picture displays, without using a Personal Computer.

Note

- Only picture files made with the Personal Computer software JPEG Viewer included with the LCD Projector and the Capture feature of the LCD Projector can be edited. Please see pages 40 - 44 regarding JPEG Viewer, or page 37 regarding Capture Feature.
- The PC-CARD EDIT mode cannot be set if Repeat play is ON. Set Repeat play to OFF before editing.

Deleting a Slide (image file)

- 1 Press **MENU** to display the menu.
 - 2 Press **∨** or **∧** to select "SET UP PC-CARD", and then **< or >** to display the screen.
 - 3 Press **∨** or **∧** to select "PC-CARD EDIT", and then **< or >** to display the screen.
- Note**
- A multi-picture screen of the selected FOLDER is displayed.
- 4 Press **∨** or **∧** to select "DELETE SLIDE", and then **< or >** to display the menu.
- Note**
- Press MENU to finish editing and return to the normal screen.
- 5 Press **∨**, **∧**, **< or >** to select the slide you want to delete.
 - 6 Press **VOLUME+** to delete the selected slide.
- When the selected slide is deleted, the "PC-CARD EDIT" screen in step 3 is redisplayed.

Note

- Once deleted a slide cannot be restored.

Moving a Slide (image file)

- 1 Press **MENU** to display the menu.
 - 2 Press **∨** or **∧** to select "SET UP PC-CARD", and then **< or >** to display the screen.
 - 3 Press **∨** or **∧** to select "PC-CARD EDIT", and then **< or >** to display the screen.
- Note**
- A multi-picture screen of the selected FOLDER is displayed.
- 4 Press **∨** or **∧** to select "MOVE SLIDE", and then **< or >** to display the menu.
- Note**
- Press MENU to finish editing and return to the normal screen.
- 5 Press **∨**, **∧**, **< or >** to select the slide you want to move.
 - 6 Press **VOLUME+** to select the slide to cut.

Note

- In this step, the slide to be moved is decided only. It cannot be cut until it is pasted.
- If you want to change your slide selection, press MENU after pressing VOLUME+.

- 7 Press **∨**, **∧**, **< or >** to select the place to move.
 - 8 Press **VOLUME+** to paste the cut slide.
- The cut slide is inserted in front of the selected slide and the "PC-CARD EDIT" screen in step 3 is redisplayed.

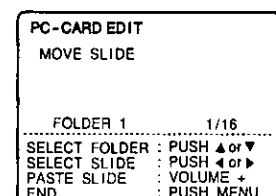
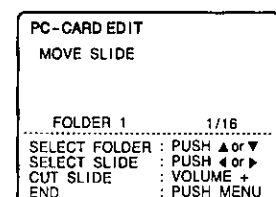
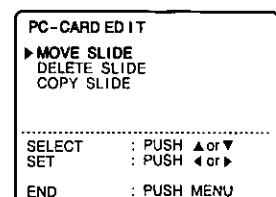
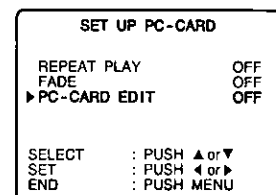
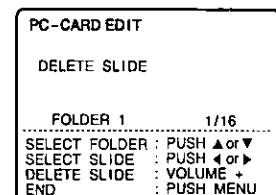
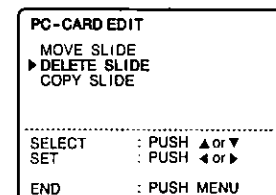
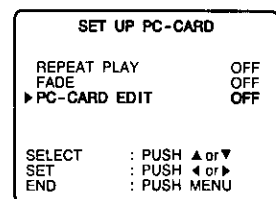

Copying a Slide (image file)

- 1 Press **MENU** to display the menu.
- 2 Press **V** or **Λ** to select "SET UP PC-CARD", and then **< or >** to display the screen.
- 3 Press **V** or **Λ** to select "PC-CARD EDIT", and then **< or >** to display the screen.
Note
 - A multi-picture screen of the selected FOLDER is displayed.
- 4 Press **V** or **Λ** to select "COPY SLIDE", and then **< or >** to display the menu.
Note
 - Press **MENU** to finish editing and return to the normal screen.
- 5 Press **V** , **Λ** , **< or >** to select the slide you want to copy.
- 6 Press **VOLUME+** to select the slide to copy.
Note
 - If you want to change your slide selection, press **MENU** after pressing **VOLUME+**.
- 7 Press **V** , **Λ** , **< or >** to select the place to paste.
- 8 Press **VOLUME+** to select the place to paste.
 - The copied slide is inserted in front of the selected slide, and the "PC-CARD EDIT" screen in step 3 is redisplayed.

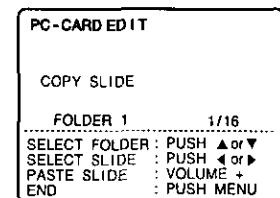
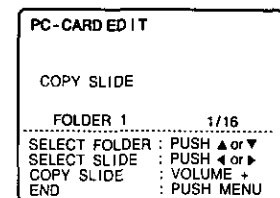
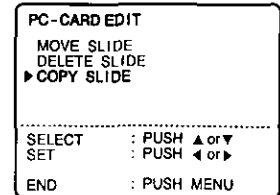
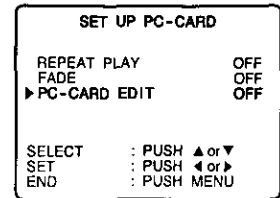

JPEG Viewer Feature

System Requirements:

- IBM PC/AT or compatible
- Microsoft Windows 95, Windows 98
- RAM: 16MB or more recommended
- 2 MB available hard disk space
- 3.5 inch 1.44MB floppy disk drive (for installation)
- PCMCIA Type II slot

Note

- It is possible that the supplied Software will not operate correctly, depending on the Hardware configuration of the PC (Personal Computer) and sharing of resources by other Applications software.
- Specifications of these Software are subject to change without notice.

JPEG Viewer Installation

EX. Windows 95

- 1 Turn on the PC** (Personal Computer) and start up Windows 95.
- 2 Insert the floppy disk** (JPEG Viewer software) into a floppy disk drive.
- 3 Select [Run...]** from the Windows 95 Start menu.

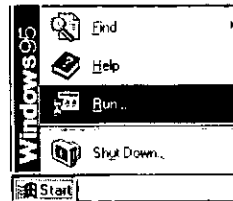

- 4 Type in [A:\SETUP.EXE] and click OK.**
 - It is assumed that your 3.5 inch 1.44MB floppy disk drive is assigned as "A" drive. If not, replace "A" with the appropriate letter.

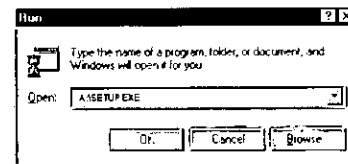

- 5 Follow the instructions as they appear on your PC screen.m**

How to make JPEG files

You can make JPEG files using the installed JPEG Viewer Software.

Capture feature : You can save captured Image of your PC (Personal Computer) screen as JPEG files. (See "When using the Capture feature" on page 42.)

Note

Existing BMP or JPEG files must be converted and saved as JPEG files ideally suited to the LCD Projector when projecting with the LCD Projector. (See "When using BMP or JPEG→ JPEG Converter feature" on page 44.)

Starting up the JPEG Viewer

EX. Windows 95

- 1 Turn on the PC** (Personal Computer) and start up Windows 95.
- 2 Insert the PC-Card** (ATA Flash Card is not supplied.) into the PC-Card Slot on your PC.
 - Note**
 - When you purchase a PC-Card, format it normally on Windows 95 before use.
- 3 Select [Start] → [Programs] → [JPEG Viewer] → [JPEG Viewer]** to open the JPEG Viewer Application.

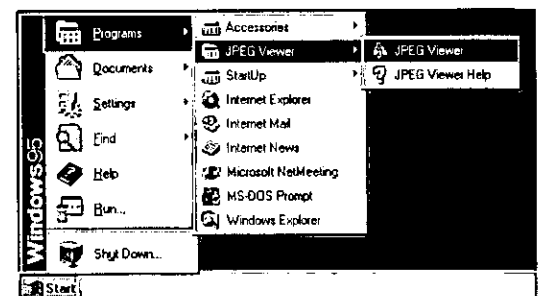

Functions of each Menu

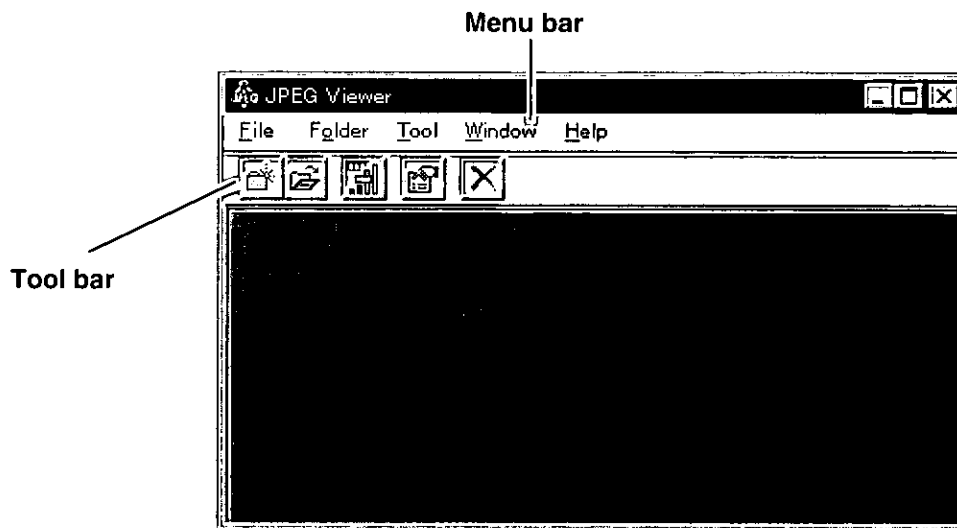

Following are the Menus and their functions contained in this software.

File

- **A**dd Graphic file to Folder Converts an original BMP or JPEG file to a JPEG file and saves it to Folder.
- **D**elete Graphic file from Folder Deletes selected images from Folder.
- **E**xit Exits the JPEG Viewer.

Folder

- **N**ew Makes new Folder.
- **O**pen Opens saved Folder.
- **C**lose Closes edited Folder.
- **D**elete Folder Deletes edited Folder.

Tool

- **C**apture Changes to the Capture mode.
- **R**emake Thumbnail Remakes Thumbnail files of images contained in the current being edited Folder.
- **O**ption Sets the JPEG Viewer.

Window

- **C**ascade Arranges windows in an overlapping pattern.
- **T**ile **H**orizontal Arranges windows in a top to bottom pattern.
- **T**ile **V**ertical Arranges windows in a left to right pattern.
- **A**rrange Icons Arranges minimized windows.

Help

- **J**PEG Viewer **H**elp Displays JPEG Viewer help.
- **V**ersion Information Displays the version information.

When using the Capture feature

1 Select [Option] from the [Tool] menu, and set the drive and JPEG quality for saving captured images.

- **PC-Card drive**
Select the PC-Card drive for saving images.
- **Wait time to start capture**
Set the waiting time from when Capture is clicked until Capturing the actual image starts. Select from 1 to 10 seconds.
- **JPEG Quality**
Set the picture quality of JPEG files to one of 5 levels.
(Please refer to Help for more details.)

Note

The setting changes back to the Default setting when RESET Button is clicked.

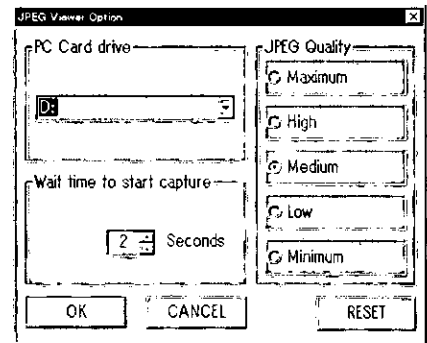

2 Select [New] or [Open] from the [Folder] menu, and then open Folder for saving images.

Note

- The Folder is also opened if you click [New] or [Open] Shortcut Button on the Toolbar.
- When creating new Folder, a consecutive number is automatically assigned to the Folder name.
Folder1, Folder2,
Do not change the Folder name.

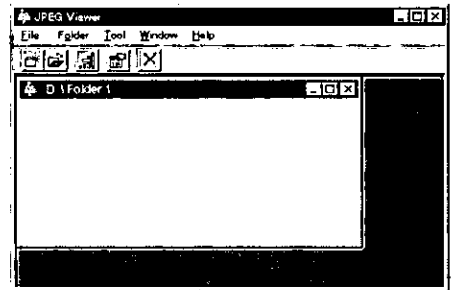

3 Select [Capture] from the [Tool] menu to display the Capture dialog.

Note

- The dialog will also be displayed if you click [Capture] Shortcut Button on the Toolbar.
- The Capture dialog is always displayed before other application screens, and the Main Window is minimized.

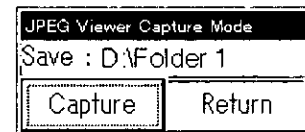

4 Start up the PC Application software and display the image you want to capture on the screen.

5 Click [Capture] Button in the Capture dialog. The displayed image will be saved to the selected Folder in JPEG format.

Note

- The images of the Capture dialog are not saved.
- File names will be automatically assigned consecutive numbers whenever saved, and Thumbnail files will be made. Thumbnail files are used when displaying a list of images in this LCD Projector or in this software.

JPEG file : Aut_0001.jpg, Aut_0002.jpg,

Thumbnail file : Thm_0001.jpg, Thm_0002.jpg,

Do not change these file names.

- Pressing [Return] Button in the Capture dialog will close this dialog.
The Main Window will be displayed. The saved image will be displayed in the Folder.

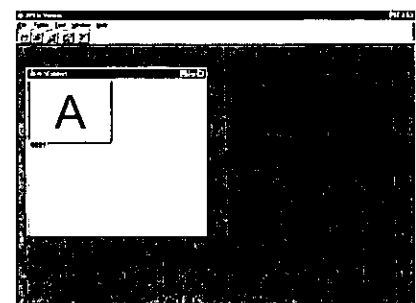

■ Size of the Projected Screen

- Because the projection image from this Projector is XGA (1024 x 768 dots), S-XGA (1280 X 1024) image will be compressed. More than S-XGA image will not be displayed.
- If the picture file is less than S-VGA (800 x 600 dot) and the expanded projection feature is on, the picture will expand as follows; 800 ---> 1024, 600 --> 768
- For the best picture quality, it is recommend that JPEG files be XGA (1024 x 768) dot in size.
- The larger the file size, the longer it takes (from when < or > is pressed) to project the picture.

■ How to edit using the Album Display feature

While confirming images displayed in an album, you can change the image display order and move images to another Folder using simple mouse operations.

Changing the image display order in Folder

- 1 Select the image you want to move.
- 2 Drag the selected image and drop it in an image in the desired location.
 - The selected image is inserted in front of the image it was dropped into.
 - The file name numbers are renewed automatically.

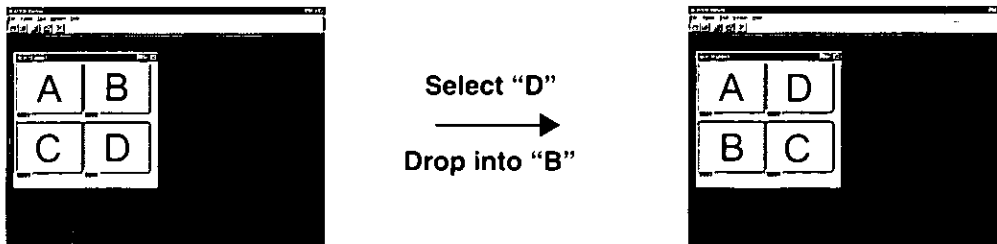

Moving the images between Folders

- 1 Open the Folder containing the image to be moved and the destination Folder.
- 2 Select the image you want to move.
- 3 Drag the selected image and drop it in the destination Folder.
 - The selected image is inserted in front of the image it was dropped into.
 - The file numbers are renewed automatically.

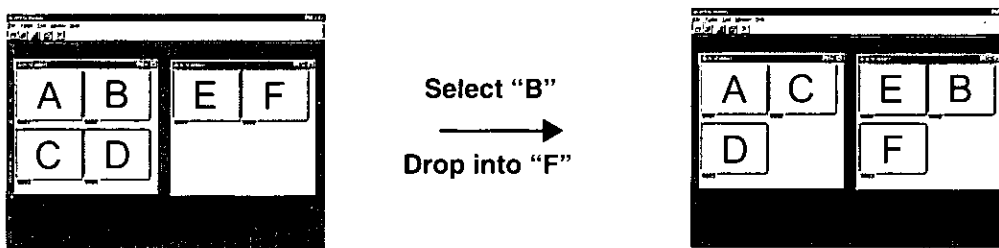

Display full-screen images for confirmation

Double click the image you want to confirm.

- The image fills the entire screen.

Note

- Click the mouse or press any button on the keyboard to return the screen to the Album Display.

Deleting images

- 1 Select the image you want to delete.
- 2 Select [Delete Graphic file from Folder] from [File] menu.
 - The image will be deleted from Folder.

Note

- You can also delete the selected image if you press the [Delete Graphic file from Folder] Shortcut Button on the Toolbar.

When using BMP or JPEG → JPEG Converter feature

1 Select **[Option]** from the **[Tool]** menu, and set the drive and JPEG quality for saving converted images.

- **PC-Card drive**
Select the PC-Card drive for saving images.
- **Wait time to start capture**
This feature is not applicable.
- **JPEG Quality**
Set the picture quality of JPEG files to one of 5 levels.
(Please refer to Help for more details.)

Note

The setting changes back to the Default setting when RESET Button is clicked.

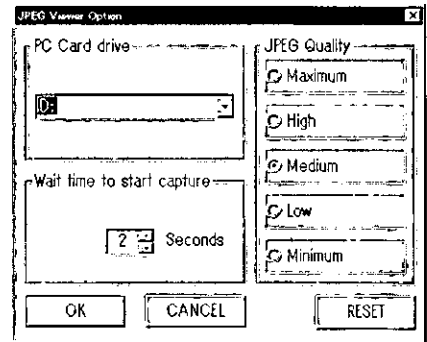

2 Select **[New]** or **[Open]** from the **[Folder]** menu, and then open Folder for saving images.

Note

- The Folder is also opened if you click **[New]** or **[Open]** Shortcut Button on the Toolbar.
 - When creating new Folder, a consecutive number is automatically assigned to the Folder name.
Folder1, Folder2,
- Do not change the Folder name.

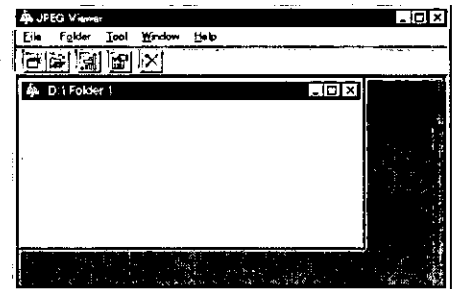

3 Select **[Add Graphic file to Folder]** from the **[File]** menu, and designate the BMP (or JPEG) file you want to convert.

- The JPEG Convert Status screen will appear and conversion will begin automatically.
- The Converted JPEG file is saved to the selected Folder.

Note

- File names will be automatically assigned consecutive numbers whenever saved, and Thumbnail files will be made. Thumbnail files are used when displaying a list of images in this LCD Projector or in this software.

JPEG file : Aut_0001.jpg, Aut_0002.jpg,

Thumbnail file : Thm_0001.jpg, Thm_0002.jpg,

Do not change these file names.

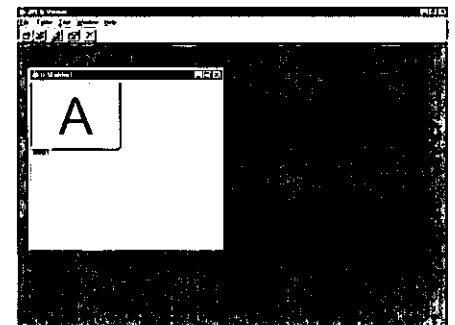

Status Code Display Indications

■ Warning Indicators

This LCD Projector has a STATUS CODE Display which calls your attention to problem conditions existing inside the LCD Projector. The LCD Projector displays a Status Code Indication each time an internal problem is detected. If any of the following indications appear in the STATUS CODE Display, immediately turn off the Main Power switch, and then see the chart to determine a course of action.

<LCD Projector>

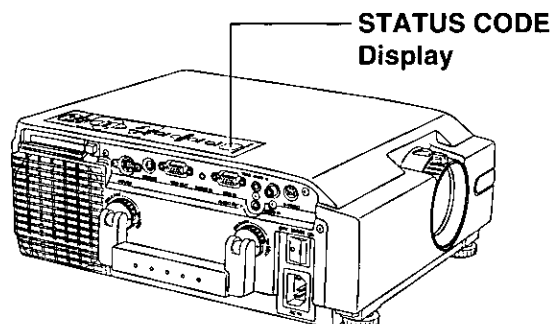

STATUS CODE	Symptom	Problem	Possible Solution
F-L	Lamp Unit automatically turns off due to abnormally high internal temperature. (Stand-by condition)	• Cooling fan malfunction.	• Take the Projector to your nearest Service Center.
F-0		• Misinstalled Air Filter Unit.	• Properly install Air Filter Unit (See page 47).
A-n		• Temperature Sensor malfunction.	• Take the Projector to your nearest Service Center.
A-0		<ul style="list-style-type: none"> • Clogged air filter. • Blocked air intake. • The surrounding temperature of the place of use may be too high. 	<ul style="list-style-type: none"> • Clean the filter (See page 47). • Relocate projector to a proper location. • Place Projector so that surrounding temperature is between 5°C (41°F) and 40°C (104°F) and the humidity is between 10% and 80% (with no condensation).
L-n	Lamp does not light up.	• Lamp is burned-out.	• Take the Projector to your nearest Service Center.
P-2		• Lamp Voltage is not correct.	
P-3	Abnormally high internal temperature.	• Abnormal temperature rise.	
P-4		• Other causes.	
L-1	Lamp operation time is over 1900 hours.	• It is nearly time to replace the Lamp Unit.	• Replace the Lamp unit. (See pages 48, 49).
L-0	Lamp operation time is over 2000 hours.	• The Lamp Unit must be replaced.	
C-d	Forced cooling fan operating to expedite lamp replacement (See page 49).	—	—

Note

- Please wait one minute before turning the power back on, to allow the lamp to cool. A much longer time may be required if the projector had attained an abnormally high internal temperature.

Removing and Attaching the Carrying Handle

The LCD Projector Carrying Handle can be removed and attached. When the Projector is set up so that it need not be moved, you can improve the appearance of the Projector by removing the handle. Please follow the instructions below to remove and attach the carrying handle.

■ When Removing the Carrying Handle

Note

- Remove the handle while in the raised position.
Removal is difficult if in the lowered position.

- 1 Hold in the two lock buttons**, located on the Lock Ring at the base of the handle as shown.
- 2 Turn the Lock Ring** to the left so that the ▲ mark points to RELEASE on the LCD Projector.
- 3 Repeat steps 1 and 2** and remove the other Lock Ring.
- 4 Slowly pull the carrying handle** straight out from the LCD Projector.

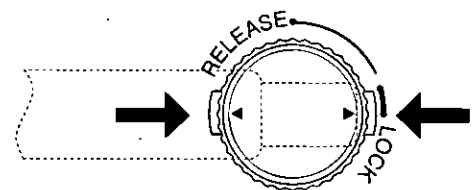
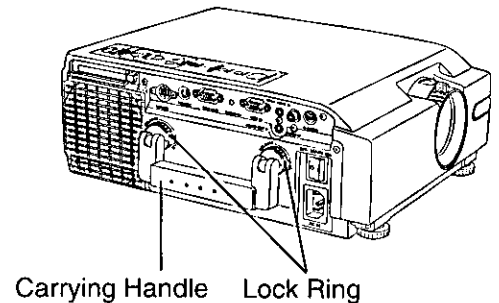

■ When Attaching the Carrying Handle

- 1 Insert the carrying handle** into the LCD Projector so that the ▲ mark on the Lock Ring is aligned with RELEASE on the LCD Projector.
- 2 Hold in the two lock buttons**, located on the Lock Ring at the base of the handle as shown.
- 3 Turn the Lock Ring** to the right so the ▲ mark points to LOCK on the LCD Projector and you hear it click into the locked position. (The Lock Ring is locked.)

Note

- Attach the carrying handle securely. If you carry the LCD Projector with the carrying handle improperly attached, the handle could come off and you sometimes cause injury.

- 4 Repeat steps 1 and 2** and remove the other Lock Ring.

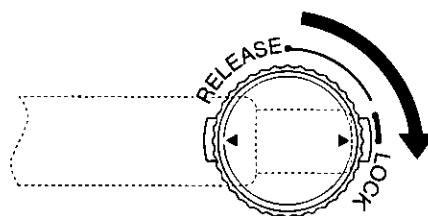
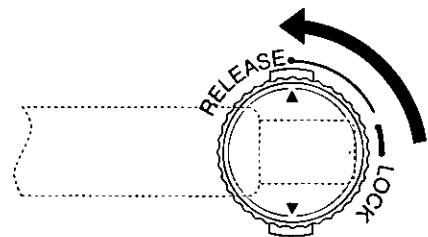

Cleaning the Air Filter

■ Air Filter

The air filter should be cleaned about every 100 hours. Also, clean the air filter if the "A-0" is indicated in the STATUS CODE display.

Replace the filter when it is clogged or dirty even after cleaning.

■ Cleaning procedure

Tools required: Vacuum Cleaner.

- Wait until the cooling fan stops and the STANDBY(R) ON(G) indicator turns solid red.

1 Set the Main Power Switch to OFF and unplug the power cord.

2 Place the LCD Projector up on its side as illustrated.

3 Remove the Air Filter unit

Hold the indent on the Air Filter unit with your hands and pull the Air Filter unit out of the LCD Projector.

4 Clean the Filter.

Gently remove any accumulated dust from Air Filter unit with your vacuum cleaner.

CAUTION: Operating LCD Projector with torn or damaged Filter may cause damage to LCD Projector.

5 Replace the Air Filter unit.

Slide the Air Filter unit into the LCD Projector until hollows in the Air Filter unit are aligned with the hollows in the Projector.

Note

- The LCD Projector power cannot be turned on unless the Air Filter unit is correctly installed.

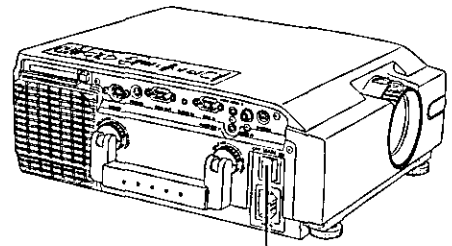

Main Power Switch

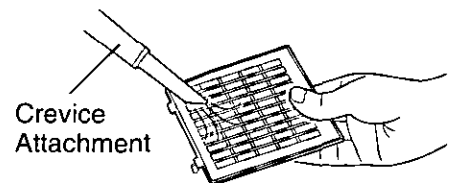
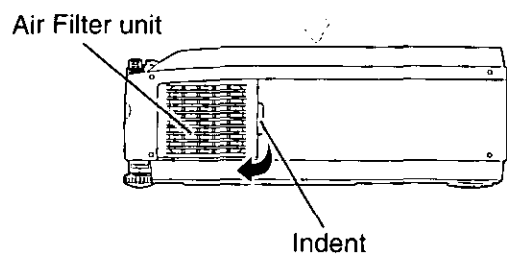

Crevice Attachment

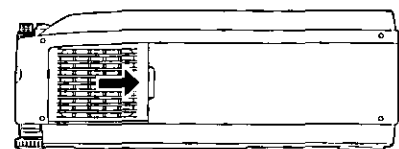

Lamp Replacement

Warning

If Status Code "L-n" (see page 45) is displayed on the Status Code Display when lamp is not turned on, take the LCD Projector to your nearest Service Center for repair as there is danger of injury due to lamp fragments.

■ Lamp replacement period

The LCD Projector lamp has a limited operating life of approximately 2000 hours.

"LAMP TIME REMAINING 10h" will be displayed on-screen when operation time reaches 1990 hours.

Then, each time the power is turned on, the Lamp life remaining will be displayed.

- A 10 second warning display (15 seconds when the LCD Projector power is turned on) will appear every 1 hour from 1990 hours of operation time. And the warning will flash during the last 5 minutes of Lamp life.

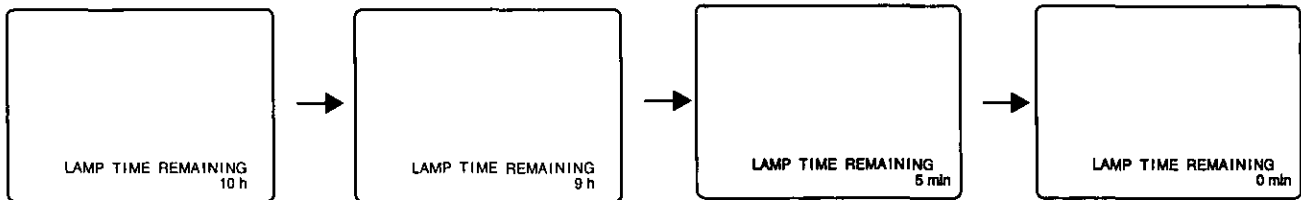

In Case Lamp Use Reaches 2000 hours

The LCD Projector will shut itself OFF and the STATUS CODE indication becomes "L-0". (See STATUS CODE on page 45.)

- Replace the Lamp as described in steps 1-7 on page 49.
- Press POWER ON, the LAMP TIME RESET display will appear to reset the Lamp time.
 - Only this screen will be displayed when POWER is pressed until lamp time is reset.
(The LCD Projector cannot display a normal picture.)
 - If the Lamp Time is not reset, this screen will disappear and the LCD Projector will shut itself OFF after about 10 minutes.
- Press < or > to select YES.
- Turn the POWER OFF to reset the Lamp Time.

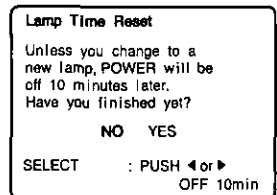

■ Lamp replacement procedure

Caution: Because of possibility of injury, strictly follow the replacement procedure below.

Order Lamp ET-LA058.

- 1 **After the cooling fan has stopped, and STANDBY(R) ON(G) indicator turns solid red. Set the Main Power Switch to OFF and unplug the power cord.**

Note: Please wait more than one hour for lamp replacement.

[If you need to replace the lamp more urgently]

- The LCD Projector has a forced cooling feature. After the POWER switch is turned OFF, and sometime during about the first minute of the normal cooling fan operation, press < and > at same time. The cooling fan will change to high speed for about 10 minutes. (The "C-d" STATUS CODE will be displayed.)

- 2 **Grabbing the handle, place the LCD Projector up on its side as illustrated.**

- 3 **Remove the Lamp cover screws.**

First read caution and warning labels on Lamp cover. Then, remove the Lamp cover screws (2) by using screw driver, and take off the lamp cover.

- 4 **Remove the Lamp unit screws.**

Remove the lamp unit screws (2), then grasp the Lamp unit handle and carefully pull it from the LCD Projector. Keep Lamp housing opening to your right. Do not touch Lamp or point Lamp opening at anyone.

WARNING: The lamp may be hot. Be careful when handling.

CAUTION:

- High-pressure lamp may be explode if improperly handled.
- Danger of injury due to lamp fragments.

- 5 **Install the new Lamp unit.**

Remove the Lamp ET-LA058 from the LCD Projector and install a new lamp unit (ET-LA058).

- Do not drop, impact of dropping may cause Lamp to explode.

- 6 **Replace the Lamp unit screws.**

Replace the Lamp unit screw and the Lamp cover screws using a coin to tighten.

- Properly dispose of old Lamp.

- 7 **Plug the LCD Projector back in by inserting Power cord in LCD Projector AC socket and set the Main Power Switch to ON.**

- 8 **Press POWER** to turn LCD Projector ON.

- 9 **Press MENU** to display the menu.

- 10 **Press Δ or ∇ to select "SET UP PROJECTOR", and then press < or > to display the screen.**

- 11 **Press Δ or ∇ to select "SET UP FUNCTION", and then press < or > to display the screen.**

- 12 **Press Δ or ∇ to select "LAMP TIME RESET", and then press < or > to display the screen.**

- 13 **Press < to > select "YES". "Push POWER Button to reset" will appear.**

- 14 **Press POWER** to reset the Lamp Time to "0".

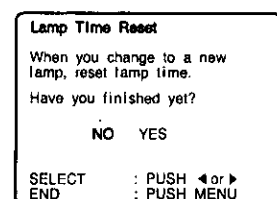
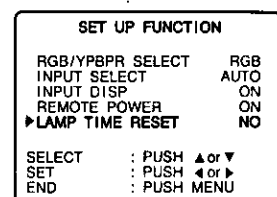
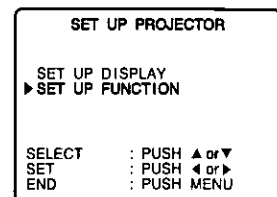
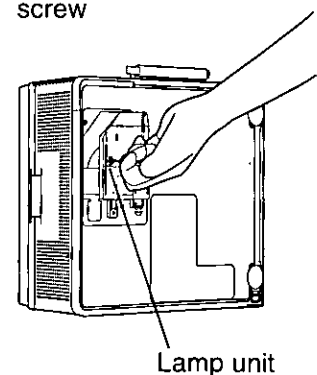
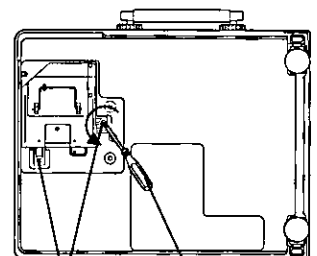
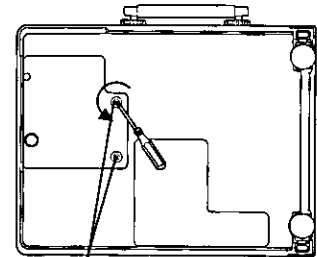
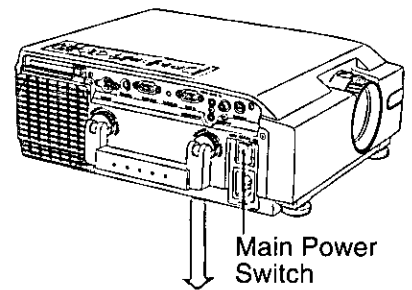

Before Requesting Service

If the LCD Projector unit fails, check the following before calling your dealer for service.

Problem	Possible Cause
Power does not turn on.	<ul style="list-style-type: none"> • The power cord may not be connected. • The main power switch on the projector may be turned off. • The main power supply may not be supplied to the wall outlet. • The Status Codes are indicated on the STATUS CODE Display. (p. 45) • The lamp unit or lamp unit cover may not have been correctly installed. (p. 49) • The Air Filter Unit may not have been correctly installed. (p. 47)
No picture appears.	<ul style="list-style-type: none"> • The lens cap may still be attached to the lens. • The signal input source may not be connected properly. (pp. 30 - 32) • The input selection setting may not be correct. (p. 16) • The BRIGHTNESS adjustment may be lowest setting. (p. 23) • The LCD Projector may be set to the SHUTTER mode. (p. 20)
The picture is fuzzy.	<ul style="list-style-type: none"> • The lens focus may not have been set correctly, or the projector may not be at the correct distance from the screen. (pp.11 - 14) • The lens may be dirty. • The LCD projector may not be set up so that it is perpendicular to the screen. (pp.11 - 14) • The VIDEO or R, G, B or PC-CARD adjustments may not have been set correctly. (pp. 21 - 26)
"FOCUS" or "NO SYNC" appears on screen.	<ul style="list-style-type: none"> • The signal input source may not be connected properly. (pp. 30 - 32) • The input selection setting may not be correct. (p. 16) • The connected signal source may be turned off. (p. 17)
Color is too light or tint is poor.	<ul style="list-style-type: none"> • COLOR or TINT adjustment may be incorrect. (p. 23) • The video formats may not match. (p. 19) • The signal cables may be connected incorrectly. For instance, the PB, PR connectors may be reversed. (p. 32)
No sound can be heard.	<ul style="list-style-type: none"> • The audio signal source may not be connected properly. (pp. 30 - 32) • The volume adjustment may be at the lowest possible setting. (p. 20) • The MUTE function or Audio/Video SHUTTER function may be active. (p. 20)
Remote Control does not operate.	<ul style="list-style-type: none"> • The batteries may be spent, or they may not be inserted correctly. (p. 7) • There may be an object blocking the infrared signals between remote control unit and the projector. • The remote control unit may be out of the operating range. (p. 7)
"CARD NG" appears on screen.	<ul style="list-style-type: none"> • A PC-Card not compatible with this LCD Projector is inserted. (p. 35)
The color is black-and white.	<ul style="list-style-type: none"> • The VIDEO system may not be correct. (p. 19)

Specifications

LCD panels		1.3" Poly silicon LCD panel(W/MLA) X 3, RGB shutter method, using Translucent TN crystal panels
Drive method		Active Matrix 4:3 Aspect Ratio panels, TFT (Thin Film Transistor)
No. of pixels		786,432 (1024 X 768) stripe pixels X 3 panels
Lens		1 -1.3 zoom lens , F2.0 - 2.5, f45 - 59mm Manual Focus
Projector lamp		220W UHM Lamp
Contrast ratio		250 : 1
Brightness		2,500 lumen / ANSI
No. of colors		16,777,216
Screen size		20" - 300" (measured diagonally)
Projection (throw) distance		2.62' - 44.29'
Lens axis shift		1 : 6 Low position
Color systems		PAL/SECAM/NTSC/PAL-M/PAL-N/NTSC4.43
Video input signal		1 Vp-p, sync negative, 75Ω terminated
S-Video input signal		Y (luminance signal) : 1 Vp-p, sync negative, 75Ω terminated C (chrominance signal) : burst 0.286 Vp-p, 75Ω terminated
RGB/YPbPr input signal	Video signal	RGB Analog (0.7 Vp-p, 1.0 Vp-p with sync on green, 75Ω) YPbPr (Y: 1.0 Vp-p, Pb, Pr: 0.7 Vp-p, 75Ω)
	Sync signal	H/V separate, H/V composite, or Sync-on-Green
	H-Frequency	24 - 85 KHz (TTL Level) ← Refer to page 17.
	V-Frequency	50 - 86 Hz (TTL Level) ← Refer to page 17.
RGB/YPbPr output signal	R.G.B.	RGB Analog (0.7 Vp-p, 1.0 Vp-p with sync on green, 75Ω) YPbPr (Y: 1.0 Vp-p, Pb, Pr: 0.7 Vp-p, 75Ω)
	HD/SYNC	Same polarity as HD/SYNC terminal of RGB IN connector (TTL Level)
	VD	Same polarity as VD terminal of RGB IN connector (TTL Level)
Connectors		S-Video Input: Mini DIN 4-pin X 1 Video Input : RCA pin X 1 Video Audio Input: M3 stereo mini pin X 1 Serial Port (RS-232C): Mini DIN 8-pin X 1 MOUSE input: 13-pin round connector X 1 RGB/YPbPr Input: D-Sub mini 15-pin X 1 RGB/YPbPr Audio Input: M3 stereo mini pin X 1 RGB/YPbPr Output: D-Sub mini 15-pin X 1 Audio output: M3 stereo mini pin X 1 PC Card Slot: PCMCIA TypeII X 1
Controls	Cabinet Buttons/ Switches	Main Power ON/OFF, Power ON/OFF, Volume +/-, Mode, Menu, Input, Λ, V, < , >, Release, Capture
	Remote Control Buttons	Power ON/OFF, Freeze, Shutter, Mute, Volume +/-, Mode, Menu, Input, Λ, V, < , >, Laser, Mouse, Click1, Click2
Audio output		1.5 W (10% THD)
Speaker		2.76" X 1.58" X 1 (70 mm X 40 mm X 1)
Operating Temperature		41°F to 104 °F (5°C to 40°C)
Operating Humidity		10% - 80% (non-condensing)
Storage Temperature		-13°F to 104°F (-25°C to 40°C) 104°F to 140°F (40°C to 60°C)
Storage Humidity		5% - 85% (non-condensing) Normal humidity
Power Supply		100 - 240 V AC (50 or 60 Hz) Automatic
Power consumption		370 W
Dimensions W x H x D		10 - 6/16" X 4 - 14/16" X 13 - 4/16" (263 X 124 X 336 mm)
Amps		3.7 A - 1.5 A
Weight		14.1 lbs. (6.4 kg)
Approvals		FCC, UL, C-UL, CE, VDE, FDA

Note

•Specifications and design subject to change without notice.

Notes importantes concernant la sécurité



ATTENTION: Lire toutes ces instructions avant d'utiliser votre projecteur. Conserver le mode d'emploi en lieu sûr afin de pouvoir le consulter ultérieurement.

Ce projecteur à affichage à cristaux liquides a été conçu et fabriqué pour répondre aux normes de sécurité en vigueur. Mais une UTILISATION INCORRECTE PEUT PROVOQUER UNE DECHARGE ELECTRIQUE OU UN INCENDIE. Afin de ne pas supprimer les protections incorporées dans ce projecteur à affichage à cristaux liquides, respectez les règles de base suivantes pour son installation, utilisation et réparation.

- 1 Débrancher le projecteur de la prise de courant murale avant d'entreprendre le nettoyage.
- 2 Ne pas appliquer des produits de nettoyage liquides ou des aérosols. Utiliser un chiffon doux et sec pour nettoyer le projecteur. Si le projecteur est très sale, tremper un chiffon dans un détergent neutre, bien essorer le chiffon, puis essuyer le boîtier et terminer en essuyant avec un chiffon doux. Ne pas utiliser un dépoussiéreur chimique ou un nettoyant lustrant parce qu'il risque de détériorer le boîtier et de décaper le revêtement de peinture.
- 3 Ne pas utiliser des accessoires non recommandés par Panasonic, car ils risquent de provoquer des dangers.
- 4 Ne pas utiliser le projecteur près de l'eau; par exemple, près d'une baignoire, un lavabo, un évier, une cuve à lessive, dans un sous-sol mouillé, près d'une piscine, etc. Ne jamais renverser de liquides dans le projecteur.
- 5 Ne pas placer le projecteur sur un chariot, un support ou une table instable. Le projecteur risque de tomber, ce qui pourrait provoquer des blessures graves à un enfant ou un adulte, et/ou endommager l'appareil. Utiliser uniquement avec un chariot ou un support recommandé par le fabricant et adapté à l'utilisation d'un projecteur à affichage à cristaux liquides.
- 6 Le montage au plafond, contre un mur ou sur une étagère doit se faire à l'aide d'un kit de montage agréé par le fabricant.
- 7 Le projecteur à affichage à cristaux liquides et le chariot doivent être déplacés avec soin. Des arrêts brusques, une force excessive et des surfaces inégales risquent de faire basculer l'équipement et le chariot.
- 8 Les fentes et orifices au dos et au fond du boîtier sont destinés à la ventilation. Afin de garantir un fonctionnement fiable du projecteur à affichage à cristaux liquides et de le protéger contre le surchauffement, ces orifices ne doivent pas être bloqués ou couverts. Ces orifices ne doivent jamais être couverts par un tissu ou un autre matériau. L'orifice du fond ne doit pas être bloqué en plaçant le projecteur à affichage à cristaux liquides sur un lit, un fauteuil, un tapis ou toute autre surface similaire. Le projecteur à affichage à cristaux liquides ne doit pas être placé près d'un radiateur ou sur le dessus ou près d'une cheminée. Le projecteur à affichage à cristaux liquides ne doit pas être encastré sauf si une ventilation correcte est assurée.
- 9 Le projecteur doit être utilisé uniquement avec le type de source d'alimentation indiquée au dos du projecteur ou dans les caractéristiques techniques. En cas de doute sur le type d'alimentation électrique de votre entreprise, consulter le revendeur de votre projecteur à affichage à cristaux liquides ou la compagnie d'électricité locale.
- 10 Ne rien poser sur le cordon d'alimentation. Ne pas placer le projecteur à affichage à cristaux liquides dans un endroit où le cordon sera sur un lieu de passage.
- 11 Respecter les avertissements et instructions marqués sur le projecteur à affichage à cristaux liquides.
- 12 Par mesure de sécurité, ce projecteur est équipé d'une prise trois conducteurs avec mise à la terre. S'il n'est pas possible d'insérer la fiche dans la prise, utiliser un adaptateur ou confier l'installation d'une prise de terre à un électricien. Ne pas essayer de modifier cette fiche secteur.
- 13 Pour améliorer la protection du projecteur à affichage à cristaux liquides pendant un orage ou lorsqu'il est laissé sans surveillance ou inutilisé pendant une longue période, débranchez la fiche de la prise murale et débranchez tous les câbles. Cela évite d'endommager le projecteur par la foudre et les surtensions des lignes d'alimentation.



- 14** Ne pas surcharger les prises murales et les cordons de rallonge avec trop d'appareils car cela risque de provoquer un incendie ou une décharge électrique.
- 15** Ne jamais enfoncer d'objets de quelque sorte dans le projecteur à affichage à cristaux liquides par les fentes du boîtier, car ils pourraient toucher des points dangereux sous haute tension ou générer des court-circuits, qui risquent de provoquer un incendie ou une décharge électrique.
- 16** Ne pas essayer de réparer le projecteur à affichage à cristaux liquides soi-même. Ouvrir ou enlever les des couvercles risque de vous exposer à une tension dangereuse ou à d'autres dangers. Confiez tous travaux de dépannage à un dépanneur qualifié.
- 17** Débrancher le projecteur à affichage à cristaux liquides de la prise murale et confiez le dépannage à un dépanneur qualifié dans les conditions suivantes:
 - A. Lorsque le cordon d'alimentation ou la fiche est endommagée ou effilochée.
 - B. Si du liquide a été renversé dans le projecteur à affichage à cristaux liquides.
 - C. Si le projecteur à affichage à cristaux liquides a été exposé à la pluie ou à l'humidité.
 - D. Si le projecteur à affichage à cristaux liquides ne fonctionne pas normalement lorsque les instructions d'utilisation ont été suivies. Réglez uniquement les commandes décrites dans les instructions d'utilisation; un réglage incorrect des autres commandes risque de provoquer des dégâts et nécessiteront souvent un travail approfondi par un technicien qualifié pour remettre le projecteur à affichage à cristaux liquides en état de fonctionnement normal.
 - E. Si le projecteur à affichage à cristaux liquides a subi une chute ou si le boîtier a été endommagé.
 - F. Lorsque le projecteur à affichage à cristaux liquides présente un changement distinct dans sa performance - cela signifie une nécessité de réparation.
- 18** A la fin de tout entretien ou réparation du projecteur à affichage à cristaux liquides, demandez au technicien du service après-vente d'effectuer une vérification de sécurité de routine afin de déterminer si le projecteur à affichage à cristaux liquides est en état de fonctionnement.
- 19** Lorsque le remplacement des pièces est nécessaire, s'assurer que le technicien du service après-vente a utilisé les pièces de remplacements spécifiées par le fabricant et ayant les mêmes caractéristiques que les pièces d'origine. Des substitutions non autorisées risquent de provoquer un incendie, une décharge électrique ou d'autres dangers.
- 20** Le filtre à air doit être nettoyé toutes les 100 heures de fonctionnement de la lampe.
Le projecteur à affichage à cristaux liquides risque de devenir trop chaud si le filtre n'est pas nettoyé lorsque cela est nécessaire.
- 21** Si l'objectif est sale ou encrassé, le nettoyer avec un chiffon propre, mouillé. Ne jamais toucher l'objectif avec les doigts.
- 22** Ne pas regarder à travers l'ouverture et l'objectif pendant que le projecteur fonctionne, car cela risque de provoquer des lésions oculaires.
- 23** Ne regardez pas dans l'émetteur du faisceau laser rouge, ou ne dirigez pas le rayon vers quelqu'un. Braquer la rayon laser dans les yeux entraîner des blessures aux yeux.

Utilisation de l'indicateur laser sur la télécommande

Lorsque le rayon laser est dirigé à l'écran, l'indicateur est affiché sur l'écran.

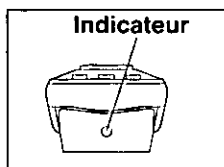

Appuyer sur **LASER** sur la télécommande pour activer le laser.

Avertissement

NE PAS regarder dans l'émetteur laser ni diriger le rayon laser vers une personne. Braquer le rayon laser dans les yeux peut entraîner des blessures aux yeux.

Remarque

- Les spécifications des radiations laser de ce produit sont les suivantes : Longueur d'onde - 650 nm, Sortie Max. - 1 mW, Classe 2.

Pour les U.S.A. seulement

- Les appareils laser de Classe 2 doivent normalement être équipés d'un indicateur précisant que le laser est émis. Sur cet appareil, le faisceau rouge émis du point de laser remplit la fonction de cet indicateur.
- Les appareils laser de Classe 2 doivent normalement être équipés d'un dispositif d'arrêt d'urgence tel qu'un obturateur pour couper immédiatement le laser. Sur cet appareil, au lieu d'un tel dispositif, le laser ne continue pas sans que le bouton laser soit maintenu enfoncé sans interruption.

ATTENTION: l'utilisation de commandes, de réglages ou l'exécution de procédures autres que celles spécifiées ici peut causer des expositions dangereuses aux radiations.

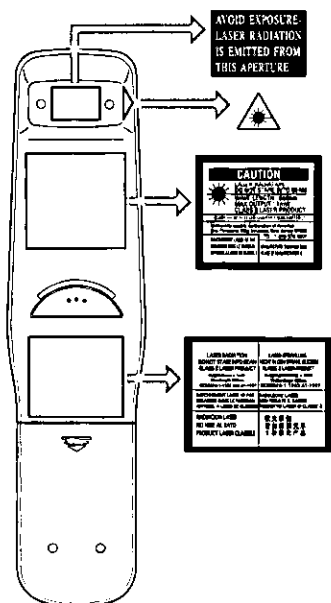

Remplacement de la lampe

Avertissement

Si le code de statut "L-n" apparaît sur l'affichage STATUS CODE (code de statut) lorsque la lampe n'est pas allumée, confiez les réparations du projecteur LCD à un centre de service car les fragments de lampe risquent de vous blesser.

■ Période de remplacement de la lampe

La lampe du projecteur LCD a une durée de service limitée de 2000 heures environ.

"DURÉE LAMPE RESTANTE 10HRS" est affiché à l'écran, lorsque la durée de service atteint 1990 heures.

Ensuite, chaque fois que le projecteur est allumé, la durée de vie restante de la lampe sera affichée.

- Un affichage d'avertissement de 10 secondes (15 secondes lorsque le projecteur LCD est allumé) apparaît toutes les heures à partir de la durée de service de 1990 heures. Et l'avertissement clignote pendant les dernières 5 minutes de la durée de vie de la lampe.

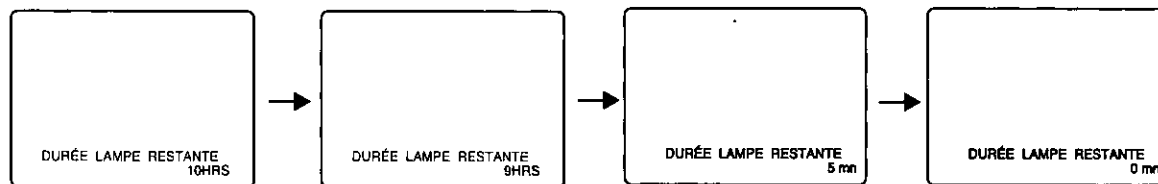

Lorsque la lampe atteint 2000 heures d'utilisation

Le projecteur LCD s'éteint automatiquement et l'indicateur STATUS CODE (code de statut) affiche "L-0".

- Remplacer l'ampoule de la manière décrite aux étapes 1-7 de la page 55.
- Appuyer sur la touche POWER ON (mise sous tension), l'affichage "INITIAL. LAMPE" (remise à zéro de la durée de service de la lampe) apparaît pour la remise à zéro de la durée de service de la lampe.
 - Seul cet écran sera affiché lorsque la touche POWER (marche) est enfoncée jusqu'à la remise à zéro de la durée de la lampe. (Le projecteur LCD ne peut pas afficher une image normale.)
 - Si la durée de la lampe n'est pas remise à zéro, cet écran apparaîtra et le projecteur LCD s'éteint automatiquement après 10 minutes environ.
- Appuyer sur la touche < ou > pour sélectionner OUI.
- Appuyer sur la touche POWER OFF (arrêt) pour remettre la durée de service de la lampe à zéro.

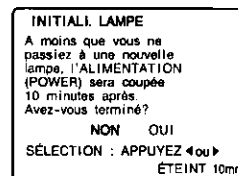

■ Procédure de remplacement de la lampe

Attention: En raison des risques de blessures, procédez exactement de la manière décrite ci-dessous pour remplacer la lampe.

Commander la lampe ET-LA058.

- 1 Lorsque le ventilateur de refroidissement s'est arrêté, et l'indicateur STANDBY(R) ON(G) (attente(R)/mise sous tension) devient rouge, régler l'interrupteur principal sur OFF et débrancher le cordon d'alimentation.**

Remarque: Attendre au moins une heure avant de remplacer la lampe.

[Pour un remplacement prématuré de la lampe]

• Le projecteur LCD possède une fonction de refroidissement forcé. Lorsque le commutateur de tension POWER est mis sur OFF (hors tension) et pendant environ la première minute du fonctionnement normal du ventilateur de refroidissement, appuyer sur < et > en même temps. Le ventilateur de refroidissement passe alors en vitesse rapide pendant 10 minutes. (Le STATUS CODE "C-d" est alors affiché.)

- 2 Tout en saisissant la poignée, placer le projecteur LCD debout sur son côté comme illustré.**

- 3 Retirer les vis du couvercle de la lampe.**

Lire d'abord les plaques de mise en garde et d'avertissement sur le couvercle de la lampe. Ensuite, retirer les (2) vis du couvercle de la lampe avec une tournevis, et sortir le couvercle de la lampe.

- 4 Retirer la vis de l'unité de la lampe.**

Retirer la vis (2) de l'unité de la lampe, puis saisir la poignée de la lampe et la sortir délicatement du projecteur LCD. Tenir l'ouverture du boîtier de la lampe à droite. Ne pas toucher la lampe et ne pas pointer l'ouverture de la lampe sur quelqu'un.

AVERTISSEMENT: La lampe risque d'être chaude. Faire attention lors de sa manipulation.

ATTENTION:

- La lampe haute pression risque d'exploser si elle est utilisée incorrectement.
- Danger de blessures par les fragments de lampe.

- 5 Installer l'unité de la lampe neuve.**

Retirer la lampe ET-LA058 du projecteur LCD et installer une unité de lampe neuve (ET-LA058).

• Ne pas faire tomber la lampe, car le choc après une chute risque de faire exploser la lampe.

- 6 Remettre les vis de l'unité de la lampe en place.**

Remettre la vis de l'unité de la lampe et les vis du couvercle de la lampe en place à l'aide d'une pièce de monnaie pour les visser.

• Eliminer la lampe usagée selon les prescriptions en vigueur.

- 7 Rebrancher le projecteur LCD en insérant le cordon d'alimentation dans la prise CA du projecteur LCD et mettre l'interrupteur principal sur la position ON (marche).**

- 8 Appuyer sur POWER (marche) pour allumer le projecteur LCD.**

- 9 Appuyer sur MENU pour afficher le menu.**

- 10 Appuyer sur ^ ou v pour sélectionner "RÉGLAGE DU PROJECTEUR", et appuyer ensuite sur < ou > pour afficher l'écran.**

- 11 Appuyer sur ^ ou v pour sélectionner "FONCTION", et appuyer ensuite sur < ou > pour afficher l'écran.**

- 12 Appuyer sur ^ ou v pour sélectionner "INITIALI. LAMPE", et appuyer ensuite sur < ou > pour afficher l'écran.**

- 13 Appuyer sur < ou > pour sélectionner "OUI".**

Remise à zéro: POWER (oui remettre la durée de service à zéro à l'aide de la touche d'alimentation) apparaît à l'écran.

- 14 Appuyer sur POWER (marche) pour remettre la durée de service de la lampe à "0".**

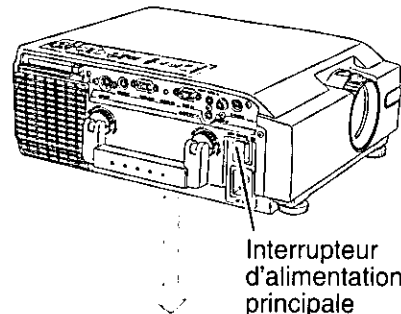

Interrupteur d'alimentation principale

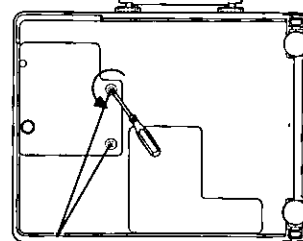

Vis du couvercle de la lampe

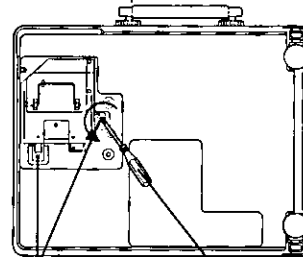

Vis de l'unité de la lampe

Tournevis

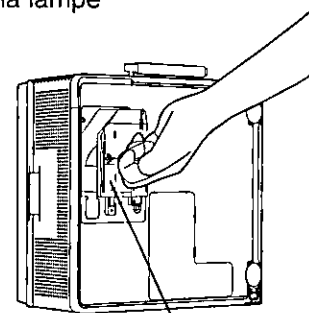

Unité de la lampe

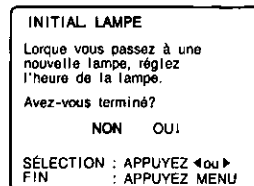
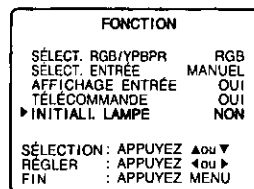
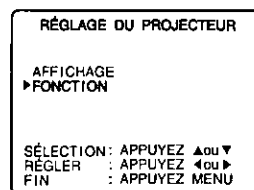

Wichtige Sicherheitshinweise



VORSICHT: Bitte lesen Sie sich diese Hinweise vor der Inbetriebnahme Ihres LCD-Projektors sorgfältig durch. Bewahren Sie die Bedienungsanleitung für spätere Referenznahme an einem sicheren Ort auf.

Elektrische Energie kann viele sinnvolle Funktionen ausführen. Dieser LCD-Projektor entspricht in seiner Entwicklung und Herstellung geltenden Sicherheitsstandards. Dennoch KANN EINE UNSACHGEMÄSSE BENUTZUNG EINEN ELEKTRISCHEN SCHLAG ODER BRAND VERURSACHEN. Um die in diesen LCD-Projektor eingebauten Sicherheitseinrichtungen nicht zu unterlaufen, beachten Sie bitte die nachfolgenden Grundregeln für die Installation, Benutzung und Wartung des LCD-Projektors.

- 1 Trennen Sie den LCD-Projektor vor der Reinigung von der Netzsteckdose ab.
- 2 Verwenden Sie für die Reinigung keine Flüssig- oder Aerosolreiniger. Wischen Sie den LCD-Projektor mit einem weichen, trockenen Tuch ab. Befeuchten Sie das Tuch im Falle einer hartnäckigen Verschmutzung mit einem neutralen Reiniger, wringen Sie das Tuch fest aus, reinigen Sie das Gerät und wischen Sie mit einem trockenen Tuch nach. Reinigen Sie das Gerät weder mit einem chemischen Tuch noch mit einem Poliermittel, da derartige Reinigungsmittel das Gerät angreifen und ein Abblättern der Farbe verursachen können.
- 3 Verwenden Sie ausschließlich von Panasonic empfohlene Zubehörteile, da die Benutzung anderer Zubehörteile Gefahren mit sich bringt.
- 4 Betreiben Sie den LCD-Projektor nicht an Orten, an denen er mit Wasser in Berührung kommen könnte, z.B. in der Nähe einer Badewanne, eines Waschbeckens, einer Spüle, in feuchten Räumen, in der Nähe eines Schwimmbeckens usw.. Schütten Sie niemals Wasser in den LCD-Projektor.
- 5 Stellen Sie den LCD-Projektor nicht auf einem wackeligen Wagen, Stativ oder Tisch auf. Der LCD-Projektor könnte herunterfallen und sowohl Kinder als auch Erwachsene ernsthaft verletzen und/oder schwerwiegende Beschädigungen des Gerätes verursachen. Benutzen Sie ausschließlich vom Hersteller empfohlene und für diesen LCD-Projektor geeignete Wagen oder Stative.
- 6 Benutzen Sie für die Decken-, Wand- oder Schrankmontage einen vom Hersteller geprüften und für diesen LCD-Projektor als geeignet befundenen Montagesatz und nehmen Sie den Einbau entsprechend der Herstellerhinweise vor.
- 7 Der LCD-Projektor, dessen Zubehör und der Wagen müssen mit Vorsicht bewegt werden. Schnelle Stopps, übermäßige Anwendung von Gewalt und unebene Flächen können zu einem Umkippen des Gerätes und des Wagens führen.
- 8 Schlitze und Öffnungen in der Gehäuserückwand und dem Gehäuseboden dienen zur Belüftung. Für einen sicheren Betrieb des LCD-Projektors und zum Schutz vor Überhitzung dürfen diese Öffnungen weder blockiert noch abgedeckt werden. Legen Sie niemals ein Tuch oder einen anderen Gegenstand auf diese Öffnungen. Die Öffnung im Gehäuseboden darf nicht dadurch blockiert werden, daß Sie den LCD-Projektor auf ein Bett, Sofa, eine Decke oder ähnliche Unterlage stellen. Ferner sollte der LCD-Projektor nicht in der Nähe oder über einem Heizkörper oder Heizlüfter platziert werden. Stellen Sie den LCD-Projektor auch nicht in einen Bücherschrank, da dort keine ausreichende Belüftung gewährleistet ist.
- 9 Der LCD-Projektor darf nur von dem auf der Rückseite des Projektors oder in den technischen Daten aufgeführten Netzquellentyp aus betrieben werden. Wenn Sie Fragen zu den an Ihrem Arbeitsplatz herrschenden Spannungsverhältnissen haben, setzen Sie sich bitte mit Ihrem Verkäufer in Verbindung, bei dem Sie das Gerät erworben haben oder Ihren LCD-Projektorhändler oder fragen Sie bei den örtlichen Stadtwerken nach.
- 10 Legen Sie keine Gegenstände auf das Netzkabel und verlegen Sie das Kabel so, daß niemand darauf treten kann.
- 11 Beachten Sie alle auf dem LCD-Projektor aufgeführten Warnungen und führen Sie die Anweisungen aus.
- 12 Zur Sicherheit ist dieser LCD-Projektor mit einem dreistiftigen Erdungsstecker ausgestattet. Der dreistiftige Erdungsstecker paßt nur in eine für die Erdung ausgelegte Netzsteckdose. Sollte der Stecker nicht passen, benutzen Sie bitte einen Adapter, der ordnungsgemäß geerdet ist oder beauftragen Sie einen Elektriker mit der Installation einer geerdeten Steckdose. Versuchen Sie nicht, diesen Wechselstromstecker in irgendeiner Weise zu verändern.
- 13 Trennen Sie sowohl den Netzstecker von der Netzsteckdose ab als auch sämtliche Kabelsysteme für den zusätzlichen Schutz des LCD-Projektors im Falle eines Gewitters, bei Abwesenheit oder bei einer Nichtbenutzung des Gerätes über einen längeren Zeitraum hinweg. Dies verhindert Beschädigungen am LCD-Projektor bei Gewitter und Spannungsschwankungen in der Netzleitung.



- 14** Überlasten Sie weder Netzsteckdosen noch Verlängerungskabel mit zu vielen Geräten, da dies einen Brand oder elektrischen Schlag verursachen könnte.
- 15** Schieben Sie keinerlei Gegenstände durch die Gehäuseschlitze in den LCD-Projektor. Die Gegenstände könnten gefährliche Spannungspunkte berühren oder Teile kurzschließen, was wiederum einen Brand oder elektrischen Schlag verursachen könnte.
- 16** Versuchen Sie nicht, den LCD-Projektor selbst zu warten. Das Öffnen oder Entfernen von Abdeckungen kann Sie gefährlichen Spannungen oder Gefahren aussetzen. Überlassen Sie sämtliche Wartungsarbeiten qualifiziertem Fachpersonal.
- 17** Trennen Sie die LCD-Projektoreinheit unter nachfolgend aufgeführten Umständen von der Netzsteckdose ab und ziehen Sie qualifiziertes Fachpersonal hinzu:
- A. Wenn das Netzkabel oder der Netzstecker beschädigt oder durchgescheuert sind.
 - B. Wenn Flüssigkeit in den LCD-Projektor eingedrungen ist.
 - C. Wenn der LCD-Projektor Regen oder Wasser ausgesetzt worden ist.
 - D. Wenn der LCD-Projektor nicht ordnungsgemäß arbeitet, obwohl die Bedienung entsprechend der Bedienungsanleitung erfolgt. Stellen Sie nur die Bedienungselemente ein, die diese Bedienungsanleitung umfaßt; eine falsche Einstellung anderer Bedienungselemente kann Beschädigungen verursachen, die nur in einem aufwendigen Arbeitsgang von einem qualifiziertem Techniker behoben werden könnten.
 - E. Wenn der LCD-Projektor heruntergefallen oder das Gehäuse beschädigt ist.
 - F. Wenn der LCD-Projektor eine deutliche Änderung der Leistungsfähigkeit aufweist - dies ist ein Anzeichen dafür, daß eine Wartung erforderlich ist.
- 18** Beauftragen Sie nach Durchführung sämtlicher Wartungs- und Reparaturarbeiten einen Kundendiensttechniker mit einer routinemäßigen Sicherheitsprüfung, um die Betriebssicherheit des LCD-Projektors sicherzustellen.
- 19** Sollten Ersatzteile benötigt werden, achten Sie darauf, daß der Kundendiensttechniker ausschließlich vom Hersteller angegebene Ersatzteile verwendet, die über dieselben Eigenschaften wie die Originalteile verfügen. Nicht zugelassene Ersatzteile können einen Brand oder elektrischen Schlag verursachen und andere Risiken darstellen.
- 20** Der Luftfilter muß nach jeweils 100-stündigem Lampenbetrieb ausgetauscht werden. Der LCD-Projektor kann sich überhitzen, wenn der Filter im Falle der Erfordernis nicht ausgetauscht wird.
- 21** Wenn das Objektiv schmutzig oder schmierig ist, reinigen Sie es mit einem sauberen, feuchten Tuch. Fassen Sie das Objektiv niemals an.
- 22** Schauen Sie während des Betriebes nicht direkt in das Gerät und in das Objektiv, da dies Augenschäden verursachen kann.
- 23** Nicht in den Laserzeiger-Sender gucken oder den Laserstrahl auf eine Person richten. Der Laserstrahl könnte sonst Augenschäden verursachen.
- 24** Wir sind bemüht Ihre Umwelt sauber und Schadstofffrei zu erhalten. Darum bitten wir Sie das nicht mehr zu reparierende Gerät bei Ihren Händler oder einer Recycling Firma abzugeben. (Diese Vorsichtsmaßnahme gilt nur für Deutschland.)

Benutzung des Laserzeigers der Fernbedienung

Wenn man mit dem Laserstrahl auf die Leinwand zeigt, wird auf der Leinwand der Zeiger abgebildet.

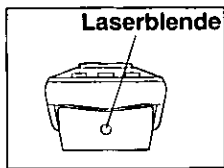

Zur Aktivierung des Lasers die **LASER-Taste** der Fernbedienung drücken.

Achtung

NICHT in den Laser-Sender gucken oder den Laserstrahl auf eine Person richten. Der Laserstrahl könnte sonst Augenschäden verursachen.

Hinweis

- Dieses Produkt besitzt folgende Laserstrahlungs-Spezifikationen: Wellenlänge - 660 nm, max. Ausgang - 1 mW, Klasse 2.

Nur für USA

- Klasse II Laserprodukte müssen normalerweise mit einer Anzeige ausgestattet sein, die anzeigt, daß der Laserstrahl emittiert wird. Bei diesem Produkt übernimmt der vom Laserpunkt emittierte rote Laserstrahl die Funktion dieser Anzeige.
- Klasse II Laserprodukte müssen normalerweise mit einer Notstopp-Einrichtung ausgestattet sein, wie einem Verschuß, damit der Laser sofort gestoppt werden kann. Anstelle solch einer Vorrichtung bleibt bei diesem Produkt der Laser nicht eingeschaltet, es sei denn, die Laser-Taste wird ununterbrochen gedrückt.

Achtung: Die Anwendung von Steuerungen oder Einstellungen oder die Ausführung von Verfahren, die nicht hier spezifiziert sind, können zu einer gefährlichen Strahlungsexposition führen.

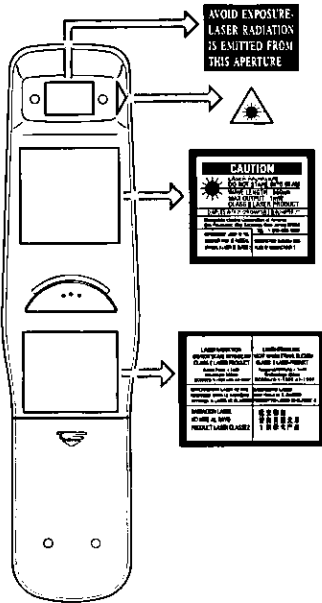

Lampenaustausch

Warnung

Falls bei nicht eingeschalteter Lampe auf dem STATUS CODE-Display der Statuscode "L-n" angezeigt wird, müssen Sie den Projektor zur nächsten kundendienststelle zur reparatur bringen, weil Verletzungsgefahr durch Lampensplitter vorhanden ist.

Lampenaustauschperiode

Die Lampe des LCD Projektors hat eine begrenzte Betriebsdauer von ca. 2000 Stunden. "RESTLEBENSDAUER LAMPE 10STD" wird auf dem Bildschirm erscheinen, wenn die Betriebsdauer 1990 Stunden erreicht hat.

Dann wird, immer wenn der Strom eingeschaltet wird, die verbleibende Betriebsdauer angezeigt.

- Eine 10-sekündige Warnungsanzeige (15 Sekunden, wenn der LCD Projektor eingeschaltet wird) erscheint jede Stunde ab einer Betriebsdauer von 1990 Stunden. Und die Warnung wird in den letzten 5 Minuten der Betriebsdauer blinken.

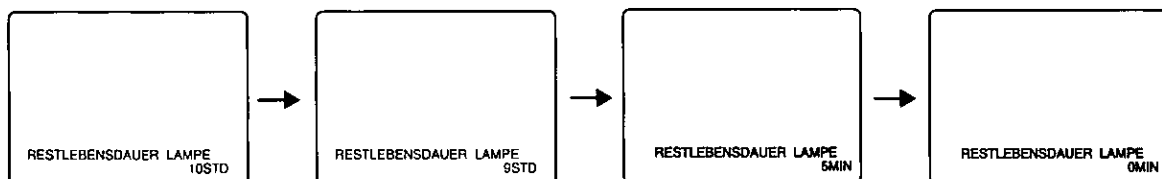

Wenn der Lampengebrauch 2000 Stunden erreicht hat

Der LCD Projektor schaltet sich selbständig ab (OFF), und auf der STATUS CODE-Anzeige erscheint "L-0".

- Tauschen Sie die Lampe aus, wie unten in den Schritten 1 bis 7 beschrieben auf Seite 59.
- Drücken Sie auf POWER ON, die "LAMPEN - RÜCK"-Anzeige erscheint, damit die Lampenzeit rückgesetzt werden kann.
 - Nur dieser Bildschirm wird angezeigt, wenn POWER gedrückt wird, bis die Lampenzeit rückgesetzt ist. (Der LCD Projektor kann kein normales Bild anzeigen.)
 - Wenn die Lampenzeit nicht rückgesetzt ist, verschwindet dieser Bildschirm und der LCD Projektor schaltet sich nach 10 Minuten selbständig ab (OFF).
- Drücken Sie < oder >, um JA auszuwählen.
- Schalten Sie den Strom ab (POWER OFF), um die Lampenzeit rückzusetzen.

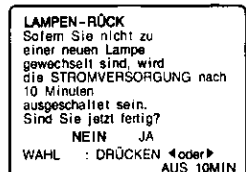

■ Lampenaustauschverfahren

Vorsicht: Wegen Verletzungsgefahr müssen die Anweisungen zum Austauschen strikt eingehalten werden.

Bestellen Sie die Lampe ET-LA058.

- 1** Nachdem das Kühlgebläse abgeschaltet ist und die **STAND BY(R) ON(G)-Anzeige** zu einem intensiven Rot wechselt. Stellen Sie den Netzschalter auf **OFF** und ziehen Sie das Stromkabel heraus.

Hinweis: Bitte warten Sie länger als eine Stunde für den Lampenaustausch.

[Wenn Sie die Lampe dringend austauschen müssen]

- Der LCD-Projektor besitzt eine focierte Kühlfunktion. Nachdem der Hauptnetzschalter POWER auf OFF geschaltet ist, drücken Sie während der ersten Minute des normalen Betriebs des Kühlgebläses < und > gleichzeitig. Das Kühlgebläse arbeitet ca. 10 Minuten mit Hochgeschwindigkeit. (Der "C-d" STATUS CODE wird angezeigt.)

- 2** Halten Sie den Griff fest und stellen Sie den LCD Projektor, wie dargestellt, auf die Seite.

- 3** Schrauben Sie die Lampenabdeckungsschrauben ab.

Lesen Sie zuerst die Vorsichts- und Warnungsaufkleber auf der Lampenabdeckung. Entfernen Sie dann mit der schraubendreher die Lampenabdeckungsschrauben (2) und nehmen die Lampenabdeckung ab.

- 4** Schrauben Sie die Lampeneinheitsschraube ab.

Schrauben Sie die Lampeneinheitsschraube (2) ab, greifen Sie den Lampeneinheitsschraubengriff und ziehen Sie sie vorsichtig aus dem LCD Projektor heraus. Lassen Sie das Lampengehäuse rechts von Ihnen geöffnet. Fassen Sie die Lampe nicht an oder zeigen Sie mit der Lampenöffnung auf niemanden.

WARNUNG: Die Lampe könnte heiß sein. Gehen Sie vorsichtig vor.

VORSICHT: • Hochdruck-Lampen könnten bei falschem Umgang explodieren.
• Verletzungsgefahr durch Lampensplitter.

- 5** Lampeneinheitsschraube.

Nehmen Sie die Lampe ET-LA058 aus dem LCD Projektor heraus und installieren Sie eine neue Lampeneinheit (ET-LA058).

- Lassen Sie sie nicht fallen, bei einem heftigen Aufprall kann die Lampe explodieren.

- 6** Schrauben Sie die Lampeneinheitsschrauben wieder an.

Schrauben Sie die Lampeneinheitsschraube und die Lampenabdeckungsschrauben mit der Münze wieder an.

- Richtige Entsorgung der alten Lampe.

- 7** Schließen Sie den LCD Projektor wieder an, indem Sie das Stromkabel in die **WS-Buchse (AC-Buchse)** des LCD Projektors stecken und den Netzschalter auf **ON** stellen.

- 8** Drücken Sie auf **POWER**, um den LCD Projektor auf **ON (EIN)** zu stellen.

- 9** Drücken Sie auf **MENU**, um sich das Menü anzeigen zu lassen.

- 10** Drücken Sie **^** oder **v**, um "GRUNDEINSTELLUNG" auszuwählen, drücken Sie dann < oder >, um den Bildschirm anzeigen zu lassen.

- 11** Drücken Sie **^** oder **v**, um "FUNKTION" auszuwählen, drücken Sie dann < oder >, um den Bildschirm anzeigen zu lassen.

- 12** Drücken Sie **^** oder **v**, um "LAMPEN-RÜCK" auszuwählen, drücken Sie dann < oder >, um den Bildschirm anzeigen zu lassen.

- 13** Drücken Sie < oder > für JA. "Zum Rücks. POWER drücken" erscheint.

- 14** Drücken Sie auf **POWER**, um die Lampenzeit auf "0" rückzusetzen.!

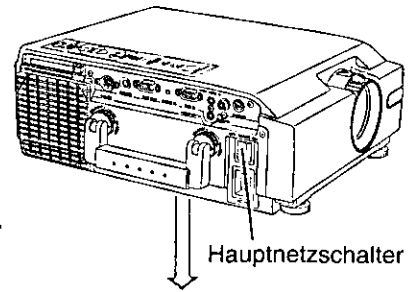

Hauptnetzschalter

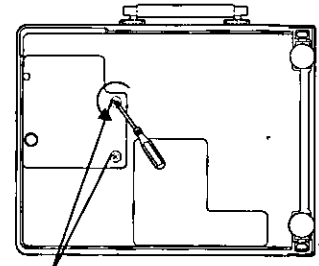

Lampenabdeckungsschrauben

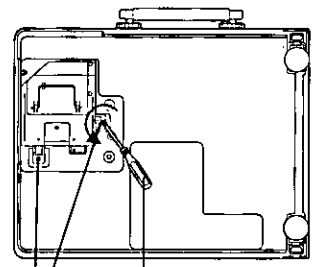

schraubendreher

Lampeneinheitsschraube

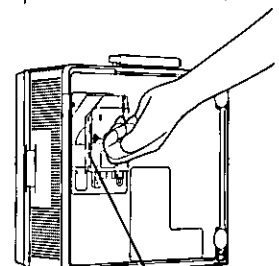

Lampeneinheit

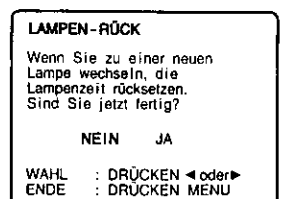
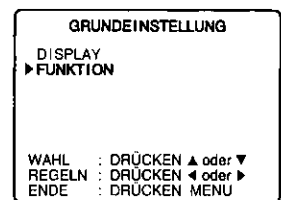

Panasonic®

Professional/Industrial Video

Panasonic Broadcast & Television Systems Company

Division of Matsushita Electric Corporation of America

Executive Office:

3330 Cahuenga Blvd., West, Los Angeles, CA 90068

EASTERN ZONE: (610) 269-8369

CENTRAL ZONE: (608) 846-4778

WESTERN ZONE: (707) 584-7189

Government Marketing Department: 52 West Gude Drive, Rockville, MD 20850 (301) 738-3840

Panasonic Canada Inc.

5770 Ambler Drive, Mississauga, Ontario L4W 2T3 (905) 624-5010

Printed in Japan
LSQT0208A
S1299G0